

**TOSHIBA**

FILE NO. 030-200225

SERVICE MANUAL

COLOUR TELEVISION

VJ13 Chassis

**43VJ22P**

# TABLE OF CONTENTS

## CHAPTER 1 GENERAL ADJUSTMENTS

SAFETY INSTRUCTIONS .....	3
CRT ASSEMBLY REPLACEMENT AND MOUNTING .....	4
PICTURE TUBE COMPONENTS ADJUSTMENT .....	6
SERVICE POSITION .....	9
SERVICE MODE .....	10
DESIGN MODE .....	13
ELECTRICAL ADJUSTMENT .....	14
CONVERGENCE ADJUSTMENT .....	15
SCREEN AND MIRROR ALIGNMENTS .....	21
CIRCUIT CHECKS .....	22

## CHAPTER 2 SPECIFIC INFORMATIONS

SETTING & ADJUSTING DATA .....	23
LOCATION OF CONTROLS .....	24
MECHANICAL DISASSEMBLY .....	26
CHASSIS AND CABINET REPLACEMENT PARTS LIST .....	27
PC BOARDS BOTTOM VIEW .....	41
TERMINAL VIEW OF TRANSISTORS .....	50
CIRCUIT BLOCK DIAGRAM .....	52
SPECIFICATIONS .....	END
APPENDIX:	
CIRCUIT DIAGRAM	

## CHAPTER 1 GENERAL ADJUSTMENTS

### SAFETY INSTRUCTIONS

**WARNING:** BEFORE SERVICING THIS CHASSIS, READ THE “X-RAY RADIATION PRECAUTION”, “SAFETY PRECAUTION” AND “PRODUCT SAFETY NOTICE” INSTRUCTIONS BELOW.

#### X-RAY RADIATION PRECAUTION

1. Excessive high voltage can produce potentially hazardous X-RAY RADIATION. To avoid such hazards, the high voltage must not be above the specified limit. The nominal value of the high voltage of this receiver is (A) kV at zero beam current (minimum brightness) under a (C) V AC power source. The high voltage must not, under any circumstances, exceed (B) kV.
2. The only source of X-RAY RADIATION in this TV receiver is the picture tube. For continued X-RAY RADIATION protection, the replacement tube must be exactly the same type tube as specified in the parts list.
3. Some part in this receiver have special safety-related characteristics for X-RAY RADIATION protection. For continued safety, parts replacement should be undertaken only after referring to the PRODUCT SAFETY NOTICE below.

Refer to table-1 for high voltage (A), (B) & AC voltage (C).  
(See SETTING & ADJUSTING DATA on page 23)

Each time a receiver requires servicing, the high voltage should be checked following the HIGH VOLTAGE CHECK procedure in this manual. It is recommended that the reading of the high voltage be recorded as a part of the service record. It is important to use an accurate and reliable high voltage meter.

#### SAFETY PRECAUTION

**WARNING :** Service should not be attempted by anyone unfamiliar with the necessary precautions on this receiver. The following are the necessary precautions to be observed before servicing this chassis.

1. An isolation transformer should be connected in the power line between the receiver and the AC line before any service is performed on the receiver.
2. Always discharge the picture tube anode to the CRT conductive coating before handling the picture tube. The picture tube is highly evacuated and if broken, glass fragments will be violently expelled. Use shatter proof goggles and keep picture tube away from the unprotected body while handling.
3. When replacing a chassis in the cabinet, always be certain that all the protective devices are put back in place, such as; non-metallic control knobs, insulating covers, shields, isolation resistor-capacitor network etc.

#### PRODUCT SAFETY NOTICE

Many electrical and mechanical parts in this chassis have special safety-related characteristics. These characteristics are often passed unnoticed by a visual inspection and the protection afforded by them cannot necessarily be obtained by using replacement components rated for higher voltage, wattage, etc. Replacement parts which have these special safety characteristics are identified in this manual and its supplements; electrical components having such features are identified by the international hazard symbols on the schematic diagram and the parts list.

Before replacing any of these components, read the parts list in this manual carefully. The use of substitute replacement parts which do not have the same safety characteristics as specified in the parts list may create shock, fire, X-ray radiation or other hazards.

## CRT ASSEMBLY REPLACEMENT AND MOUNTING

**CAUTION :** DO NOT LOOSEN THE HEX HEAD BOLTS WITH SPRINGS (12 PCS), BECAUSE THOSE ARE FOR SEALING OF CRT COOLANT.

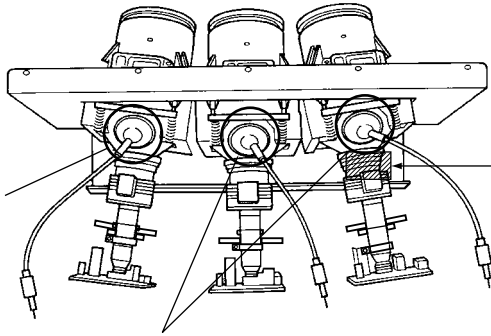

### Attention Serviceman

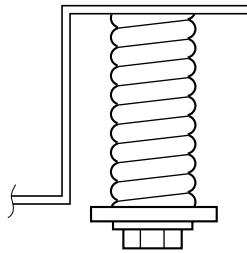

The Hex Head Bolts with Springs. (see sketch) used on CRT assembly, are **“NOT”**

Adjustment Screws  
**DO NOT LOOSEN-FLUID LEAKAGE WILL OCCUR.**

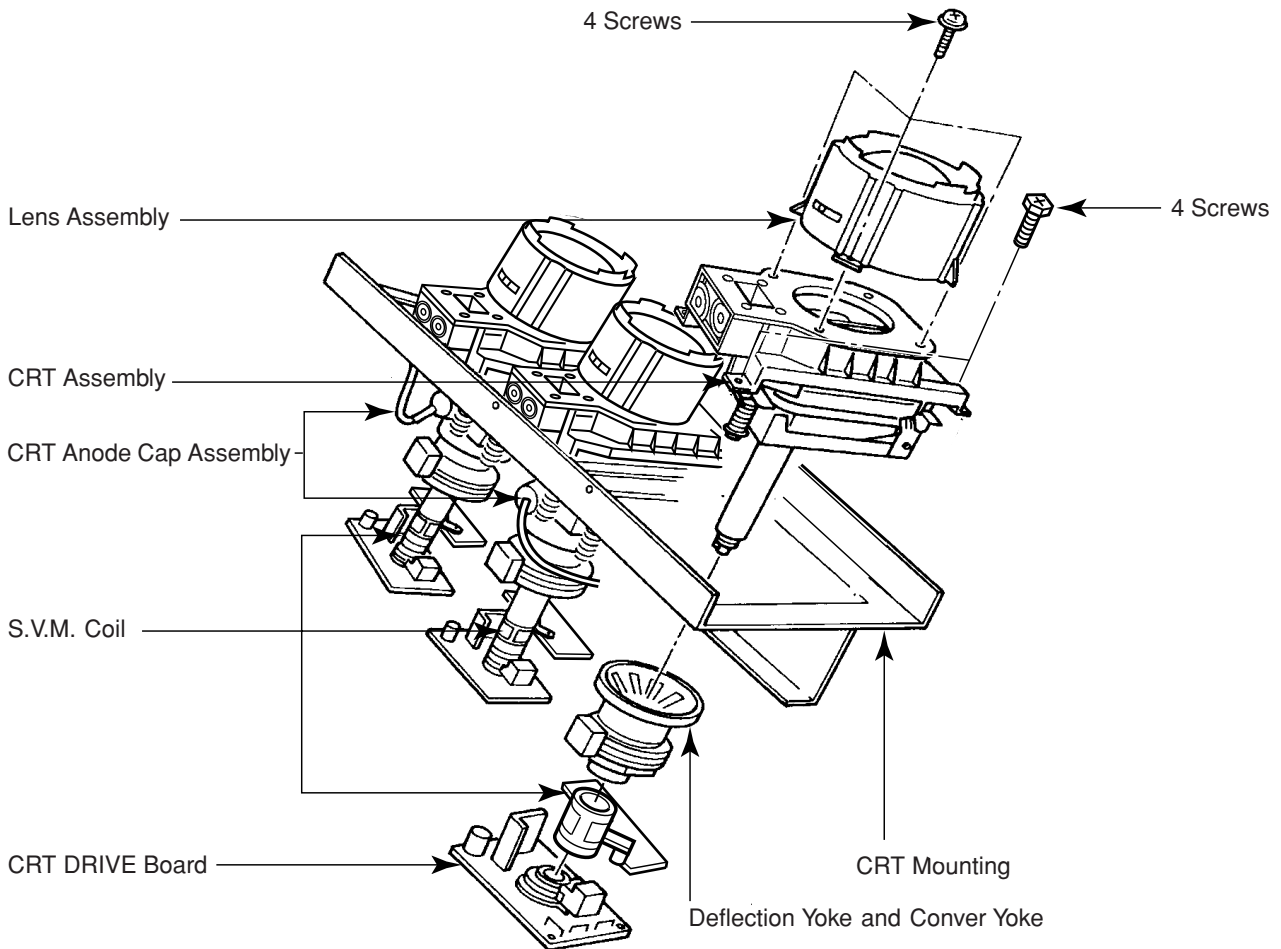

**Lens and Neck Components View**

TO REMOVE CRT (Same procedure for R, G, B)

1. Remove CRT DRIVE Board, S. V. M. COIL and DEF. YOKE from CRT.
2. Remove Lens Assembly.
3. Detach CRT Anode Cap from CRT.
4. Remove CRT Assembly from CRT Mounting.

CRT REPLACEMENT (Same procedure for R, G, B)

Reverse the removal procedures except the followings.

1. Anode Cable should be replaced with new one.  
See "SERVICING PRECAUTIONS" shown below.
2. Install silicon (T461B) to the CRT, replace the Anode cable and put enough silicon again on around the Anode Cap as illustrated.

CAUTION: Align the Anode cable as illustrated on page 4.

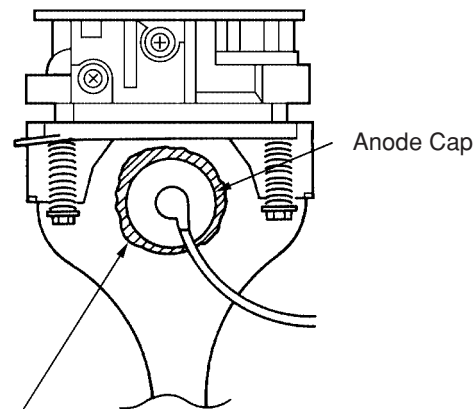

Silicon  
(On shaded area)  
TSE3843W #23960136

ADJUSTING PROCEDURE IN REPLACING CRT

1. R.G.B. CUTOFF (SCREEN VR) ADJUSTMENT (page 6.)
  2. R.G.B. FOCUS ADJUSTMENT (page 6.)
  3. PICTURE TILT ADJUSTMENT (page 7.)
  4. USER CONVERGENCE CENTER CHECK  
(Refer to owner's manual.)
  5. CENTERING ADJUSTMENT (page 7.)
  6. CONVERGENCE ADJUSTMENT (page 20.)
  7. WHITE BALANCE ADJUSTMENT (page 14.)
- Adjustments are complete.

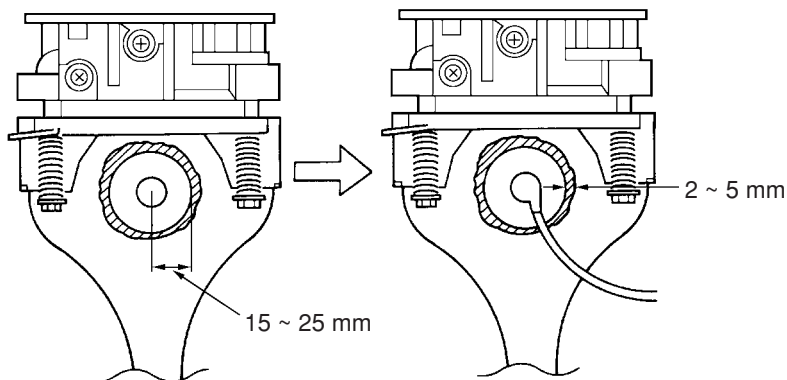

### SERVICING PRECAUTIONS

- Do not use a magnetized screw driver for screws of Deflection Yoke and Velocity Modulation Coil to avoid magnetization of electron gun. Magnetization of electron gun will degrade basic function and result in unbalance of right and left shift of user static convergence, and result in no variable quantity.

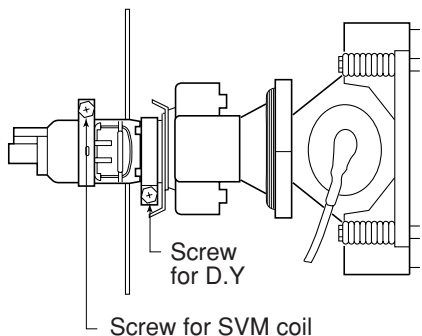

- When replacing the anode cap assembly (CRT) or anode lead assembly (F.B.T.), remove the anode lead holder from old one and attach the holder again to new anode lead.

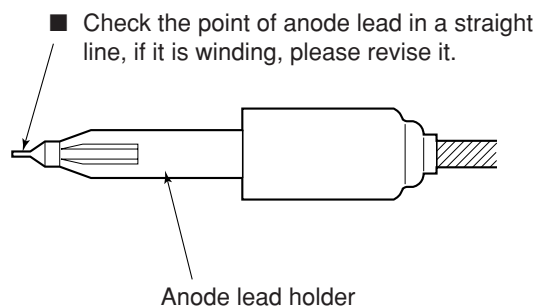

**WARNING:** BEFORE SERVICING THIS CHASSIS, READ THE "X-RAY RADIATION PRECAUTION", "SAFETY PRECAUTION" AND "PRODUCT SAFETY NOTICE" ON PAGE 3 OF THIS MANUAL.

## PICTURE TUBE COMPONENTS ADJUSTMENT

### ADJUSTING PROCEDURE IN REPLACING CRT

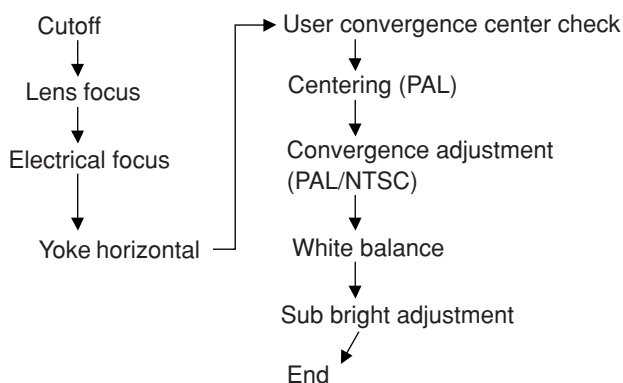

### DESCRIPTION OF NECK COMPONENTS

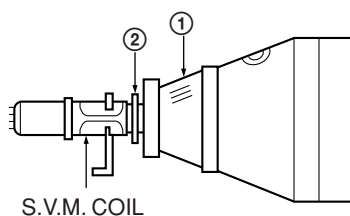

- ① Deflection yoke and convergence yoke.  
The position on the neck is required most front (CRT funnel side) and the screw is fastened after rotating yoke adjusting picture tilt.
- ② Centering magnet  
After adjusting picture tilt, picture position is finally fixed by this magnet.  
In order to get maximum margin of user convergence control for center of screen, this magnet have to be used for center convergence adjustment.

#### PREPARATION

Operate the receiver for at least 5 minutes.

### R, G, B CUTOFF (SCREEN VR) ADJUSTMENT

1. Adjust before replace the screen assembly.
2. Set user control to reset position.  
( CONTRAST → Max  
BRIGHTNESS, COLOR, TINT → Center. )
3. Call up the adjustment mode display, then select the item RCUT.
4. Adjust the data of items **RCUT**, **GCUT**, and **BCUT** to "40H".
5. Press the **-/-** button on Remote. (Y-MUTE : ON)
6. Gradually rotate R, G and B screen volume of FOCUS PAC clockwise or counterclockwise until the raster appears slightly on the CRT through the each lens, and leave them.  
(Lookin to the lens in order to check the raster.)
7. Press the **-/-** button on Remote. (Return to Normal Picture)

### RGB FOCUS ADJUSTMENT

1. Connect a VIDEO signal generator which generates a cross-hatch pattern.
2. Receive a white cross-hatch pattern by pressing the signal slection key on the VIDEO signal generator.
3. Expose only RED by covering the GREEN and BLUE lenses with caps.
4. Loosen the RED lens fixing screws (refer to Fig. a), and adjust the RED lens focus to obtain the sharpest point while observing the middle and peripheral sections of the screen.

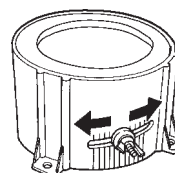

Fig. a

5. Use the focus VR of "R" of the focus pack in order to adjust the electric focus in the middle and peripheral sections of the screen to its sharpest level.
6. Check the RED focus of the whole screen and if necessary repeat steps 4 and 5.
7. Fix the RED lens by tightening its fixing screws.
8. Expose only GREEN by covering the RED and BLUE lenses with caps.
9. Display the internally-generated cross-hatch signal.
10. Adjust the GREEN lens focus on the left border of the screen to its sharpest level, then check the focus on the right border, and if it is at its sharpest level, fix it in that position by tightening the lens screws.

- (1) If the horizontal line toward the right border is red-flared, turn the lens screw slightly right in order to balance it with the left border. (After adjustment, the left border tends to be slightly green-flared, and the right border tends to be slightly red-flared.)
- (2) If the horizontal line toward the right border is green-flared, turn the lens screw slightly left in order to balance it with the left border. (After adjustment, the left border tends to be slightly red-flared, and the right border tends to be slightly green-flared.)

Note: The aim of the above-described adjustment procedure for the Green lens focus is to obtain the best lens focus after 2 - 3 hours of warming up taking into account the focus drift; it applies if the warming up time before the adjustment is less than 30 minutes. (The horizontal line in the screen middle section tends to be slightly red-flared.)

In case of warming up of more than 2 hours under a condition that the large anode current is running through the projection tube so that for example the all-white pattern appears, adjust to obtain the sharpest focus while observing the whole screen like in the RED case.

11. Use the focus VR of "G" of the focus pack in order to adjust the electric focus in the middle section of the screen to its sharpest level.

Note: Normally the most clearly visible point of the scanning line is the sharpest point of the Green focus, however as the characteristics vary depending on the projection tube, the sharpest focus points of the vertical and horizontal lines may not match each other, thus when you turn the focus VR, if the picture tends to be tremendously unstable (rolls horizontally or vertically), adjust the balance of the vertical and horizontal lines to its best position.

12. Check the GREEN focus of the whole screen and if necessary repeat steps 10 and 11.
13. Fix the GREEN lens by tightening up its fixing screws.
14. Expose only BLUE by covering the RED and GREEN lenses with caps.
15. Loosen the BLUE lens fixing screws (refer to Fig. a), and adjust the BLUE lens focus while observing the middle and peripheral screen sections.
16. Use the focus VR of "B" of the focus pack in order to adjust the focus in the middle section of the screen to its sharpest level.  
(The point of the Blue focus becomes sharpest when the brightness level of BLUE is lowest, the cross-hatch is clearly visible.)
17. Check the BLUE focus of the whole screen and if necessary repeat steps 15 and 16.
18. Fix the BLUE lens by tightening its fixing screws.

#### TILT ADJUSTMENT

Rotate R, G, B deflection yoke so that picture becomes horizon, then fasten screw.

#### CENTERING ADJUSTMENT

1. Stretch threads towards the center of the screen (top and bottom, left and right).

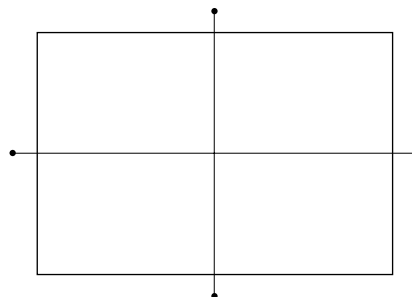

2. Enter to the user's Convergence Adjustment Mode from the menu.

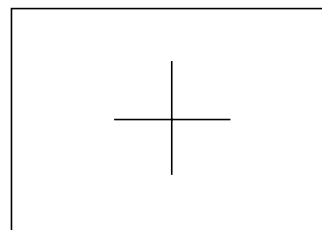

3. Adjust G centering magnet so that the cross pattern center comes to screen center.
4. Perform HEIGHT adjustment. (See page 14.)
5. Perform VERT. LINEARITY adjustment. (See page 14.)
6. Perform WIDTH adjustment. (See page 14.)
7. Check whole quality of green line.
8. Adjust R, B centering magnet so that the cross pattern center comes to screen center.

## LOCATION OF SCREEN AND FOCUS VR'S

To remove the Speaker grille and Front panel.

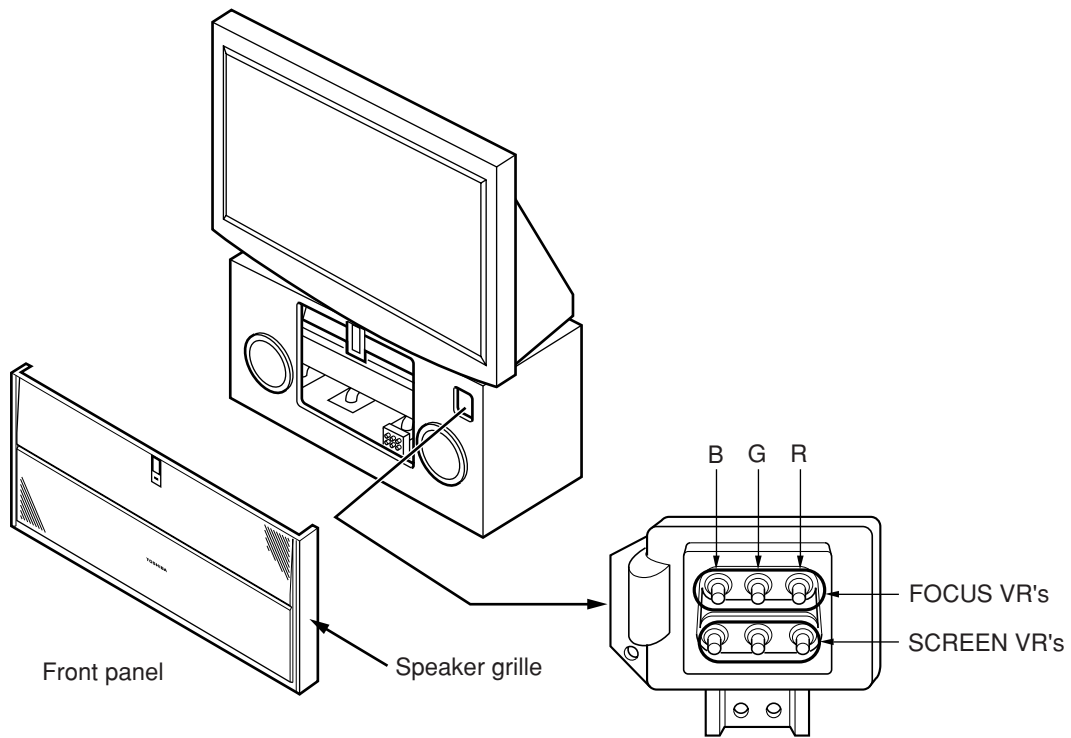

## REPLACEMENT OF HIGH VOLTAGE CABLE

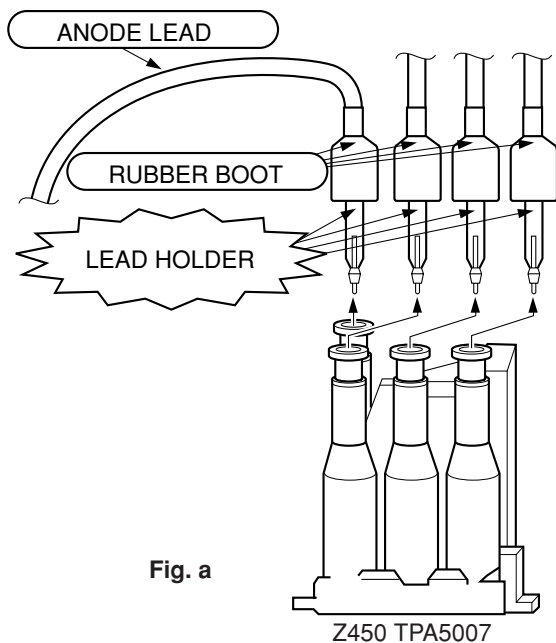

Fig. a

1. When replacing Anode Lead or Anode Cap with new one, remove Lead Holder from old lead as shown in figure below, and put it on new lead. Do not throw away Lead Holder.

**NOTE : THE LEAD HOLDER IS ATTACHED TO TPA5007 (Z450), BUT IS NOT ATTACHED TO ANODE LEAD AND ANODE CAP. RUBBER BOOT IS ATTACHED TO ANODE LEAD AND ANODE CAP.**

2. Detaching Lead Holder

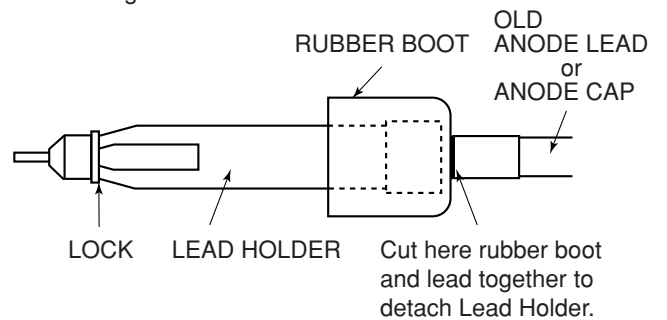

Fig. b



**WARNING:** BEFORE SERVICING THIS CHASSIS, READ THE "X-RAY RADIATION PRECAUTION", "SAFETY PRECAUTION" AND "PRODUCT SAFETY NOTICE" ON PAGE 3 OF THIS MANUAL.

## SERVICE POSITION

In order to assure the performance, processed wires shall be replaced after the repair work.

Work procedures are as follows:

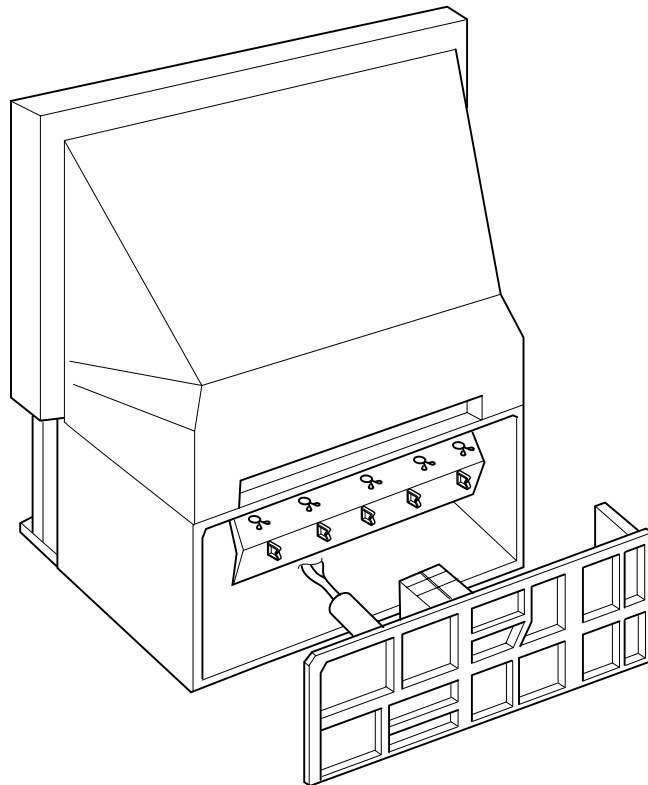

1. Remove the back board.
2. Remove lead wires.
3. Draw out the chassis.
4. Rest the chassis against the back cabinet, chassis as shown bellow.

After repair work finished, replace it in the opposite procedure.



## SERVICE MODE

### 1. ENTERING TO SERVICE MODE

- 1) Press  button once on Remote Control.
- 2) Press  button again to keep pressing.
- 3) While pressing the  button, press MENU button on TV set.

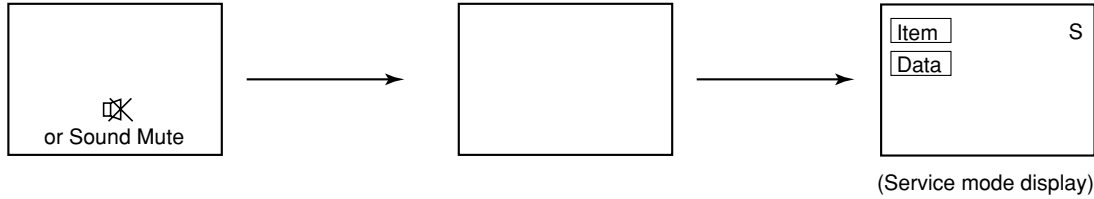





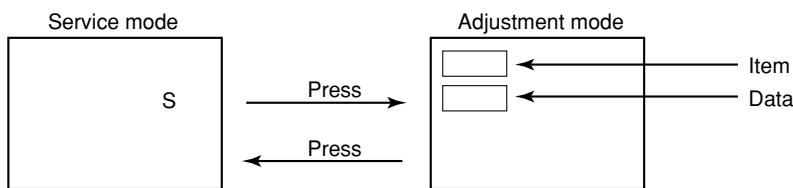

### 2. DISPLAYING THE ADJUSTMENT MENU

- 1) Press MENU button on TV.



### 3. KEY FUNCTION IN THE SERVICE MODE

The following key entry during display of adjustment menu provides special functions.

Screen adjustment mode ON/OFF:	-/-- button (on Remote)
Test signal selection :	 button (on Remote)
Selection of the adjustment items :	Channel  /  (on TV or Remote)
Change of the data value :	Volume  +/- (on TV or Remote)
Adjustment menu mode ON/OFF :	MENU button (on TV)
Initialization of the memory (QA02) :	CALL + Channel button on TV (  )
Reset the count of operating protect circuit to "00":	CALL + Channel button on TV (  )
"RCUT" selection :	1 button
"GCUT" selection :	2 button
"BCUT" selection :	3 button
"SCNT" selection (in BRTC VIDEO mode):	4 button
"COLP" selection :	5 button - - - - - Color thickness correction
"TNTC" selection :	6 button
Convergence adj :	YELLOW button
Self diagnostic display ON/OFF :	9 button

note: Displayed differently as shown below, depending on the setting of the receiving color system.  
COLP (PAL)  
COLC (NTSC)  
COLS (SECAM)

CAUTION : Never try to perform initialization unless you have changed the memory IC.

#### 4. SELECTING THE ADJUSTING ITEMS

- 1) Every pressing of CHANNEL ▲ button in the service mode changes the adjustment items in the order of table-2. (▼ button for reverse order)

Refer to table-2 for preset data of adjustment mode.  
(See SETTING & ADJUSTING DATA on page 23)

#### 5. ADJUSTING THE DATA

- 1) Pressing of VOLUME ▲ +/- button will change the value of data in the range from 00H to FFH. The variable range depends on the adjusting item.

#### 6. EXIT FROM SERVICE MODE

- 1) Pressing POWER button to turn off the TV once.

#### ■ INITIALIZATION OF MEMORY DATA OF QA02

After replacing QA02, the following initialization is required.

1. Enter the service mode, then select any register item.
2. Press and hold the CALL button on the Remote, then press the CHANNEL ▲ button on the TV. The initialization of QA02 has been completed.
3. Check the picture carefully. If necessary, adjust any adjustment item above.  
Perform "Auto search Memory" on the owner's manual.

CAUTION: Never attempt to initialize the data unless QA02 has been replaced.

## 8. SELF DIAGNOSTIC FUNCTION

- 1) Press "9" button on Remote Control during display of adjustment menu in the service mode.  
The diagnosis will begin to check if interface among IC's are executed properly.
- 2) During diagnosis, the following displays are shown.

```

<SELF CHECK>
① 2300****(SAA556*PS/M3/****)
② TIME      : 000000
③ POWER     : 0
④ BUS LINE  : OK
⑤ BUS CONT  : OK
⑥ BLOCK     : UV V1 V2 V3
  
```

- ① Part number of microcomputer (QA01)
- ② Total hour of turn the TV on. (Unit: H)
- ③ Operation number of protecting circuit ----"00" is normal.  
When indication is other than "00", overcurrent apt to flow, and circuit parts may possibly be damaged.
- ④ BUS LINE ----"OK" is normal.  
When indication shows "SDA-GND", the SDA line may possibly be shorted to GND..
- ⑤ BUS CONT ----"OK" is normal.  
When indication shows "Q○○○ NG", the device with the number may possibly be damaged.
- ⑥ BLOCK  
UV : TV reception mode  
V1 : VIDEO 1 input mode (←①)  
V2 : VIDEO 2 input mode (←②)  
V3 : VIDEO 3 input mode  
V4 : VIDEO 4 input mode

Indicated color of mode now selected : Green and Red  
Indicated color of other modes : Black

Green : Normal

Red : The microcomputer operates to provide judgement of no video signal. The red color is still indicated though the signal is input, failure may exist in input signal line including QV01.

NOTE: (1) In case that "on timer" indicator is blinking with interval of 0.5 seconds; it means protecting circuit (Current limiter) is operating, and circuit components may possibly be damaged. Check related components.

(2) In case that "on timer" indicator is blinking with interval of 1 second; Protecting circuit does not operate, but a part of Bus line does not operate normally. Check Bus line.

\* The items marked with ■ are not usable to display in the SELF DIAGNOSTIC FUCTION for some model.

# DESIGN MODE

## 1. ENTERING TO DESIGN MODE

- 1) Select the Service mode.
- 2) While pressing CALL button on Remote and press MENU button on TV.
- 3) Press MENU button on TV.

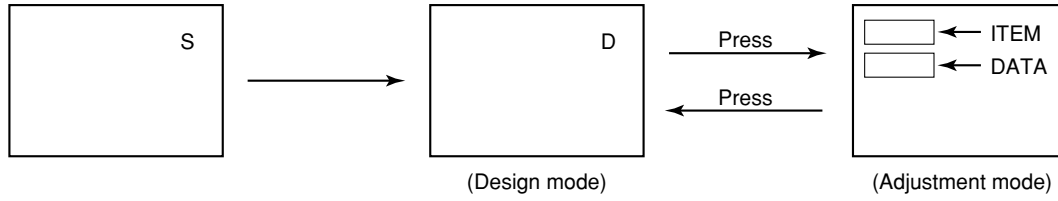

## 2. SELECTING THE ADJUSTING ITEMS

Every pressing of CHANNEL ▼ button in the design mode changes the adjustment items in the order of table-3. (▲ button for reverse order)

Refer to table-3 for data of design mode.  
(See SETTING & ADJUSTING DATA on page 23)

## 3. ADJUSTING THE DATA

Pressing of VOLUME ▲ or ▼ button will change the value of data.

## ELECTRICAL ADJUSTMENT

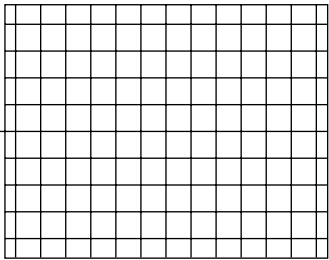
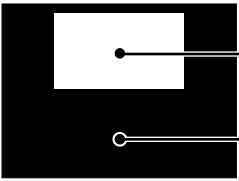
ITEM	ADJUSTMENT PROCEDURE
<p>WIDTH (WID)</p>	<ol style="list-style-type: none"> <li>Call up the adjustment mode display, then select the item <b>WID</b>.</li> <li>Press the VOLUME ▼ button to get the picture so the left or right edges of raster begins to lack.</li> <li>Press the VOLUME ▲ button to advance the data by 12 steps.</li> </ol> <p>Note : Check the horizontal picture position is correct.</p>
<p>VERTICAL LINEARITY (VLIN)</p>	<ol style="list-style-type: none"> <li>Call up the adjustment mode display, then select the item <b>VLIN</b>.</li> <li>Receive the cross-hatch pattern which appears on the screen by the signal generator.</li> <li>Press the VOLUME ▲ or ▼ button to obtain the picture of the best linearity</li> </ol> <div style="text-align: right; margin-right: 50px;">  <p style="margin-left: 10px;">Center</p> </div>
<p>HEIGHT (HIT)</p>	<ol style="list-style-type: none"> <li>Call up the adjustment mode display, then select the item <b>HIT</b>.</li> <li>Press the VOLUME ▼ button to get the picture so the top or bottom of raster begins to lack.</li> <li>Press the VOLUME ▲ button to advance the data by 11 steps.</li> </ol> <p>Note : Check the vertical picture position is correct.</p>
<p>WHITE BALANCE (RCUT) (GCUT) (BCUT) (RDRV) (BDRV)</p>	<p>Black and White pattern</p> <div style="display: flex; align-items: center; margin-bottom: 10px;">  <div style="margin-left: 10px;"> <p>High light area Adjust "RDRV" or "BDRV" to be white.</p> <p>Low light area Fine adjust "RCUT", "GCUT" or "BCUT" to be black.</p> </div> </div> <ol style="list-style-type: none"> <li>Set user control to reset position.  <div style="text-align: center; margin: 5px 0;"> <span style="font-size: 2em;">(</span> <span style="display: inline-block; text-align: left; vertical-align: middle;">           CONTRAST → Max            BRIGHTNESS, COLOR, TINT → Center.         </span> <span style="font-size: 2em;">)</span> </div> </li> <li>Call up the adjustment mode display, then select the item RCUT.</li> <li>Adjust the data of items <b>RCUT</b>, <b>GCUT</b>, and <b>BCUT</b> to "40H".</li> <li>Press the -/-- button on Remote. (Y-MUTE : ON)</li> <li>Gradually rotate R, G and B screen volume of FOCUS PAC clockwise or counterclockwise until the raster appears slightly on the CRT through the each lens, and leave them. (Lookin to the lens in order to check the raster.)</li> <li>Press the -/-- button on Remote. (Return to Normal Picture)</li> <li>Press the ⊖ button on Remote, and select the Black and White pattern.</li> <li>Adjust the data of items <b>RCUT</b>, <b>GCUT</b> and <b>BCUT</b> for proper white-balanced picture in low light area.</li> <li>Adjust the data of items <b>RDRV</b> and <b>BDRV</b> for proper white-balanced picture in high light area.</li> <li>Check the white balance in both low and high light areas. If necessary, perform again steps from 8 to 9.</li> </ol>

# CONVERGENCE ADJUSTMENT

## 1. SCREEN ADJUSTMENT

The adjustment is carried out on four screens; 4 : 3 and 16 : 9 screens in both PAL and NTSC modes. When making the adjustments, feed an external signal to make a synchronization.

**Note:**

The convergence circuit is a circuit to eliminate screen distortion and can not make a drastic correction such as to correct entire screen size. An excessive correction may actuate the protection circuit. So a care will be necessary.

Before proceeding to the adjustment for each screen, always perform the adjustments for vertical size (HIT) and horizontal size (WID) with the main deflection data changed.

Order of the adjusting screens is PAL 4 : 3 → PAL 16 : 9 → NTSC 4 : 3 → NTSC 16 : 9.

The menu order is 1 → 2 → 3 .... when the vertical sync is 50 Hz. (In this case, item 4~6 are not displayed)

The menu order is 4 → 5 → 6 .... when the vertical sync is 60 Hz. (In this case, item 1~3 are not displayed)

### 1-1. Entering the Adjustment Menu

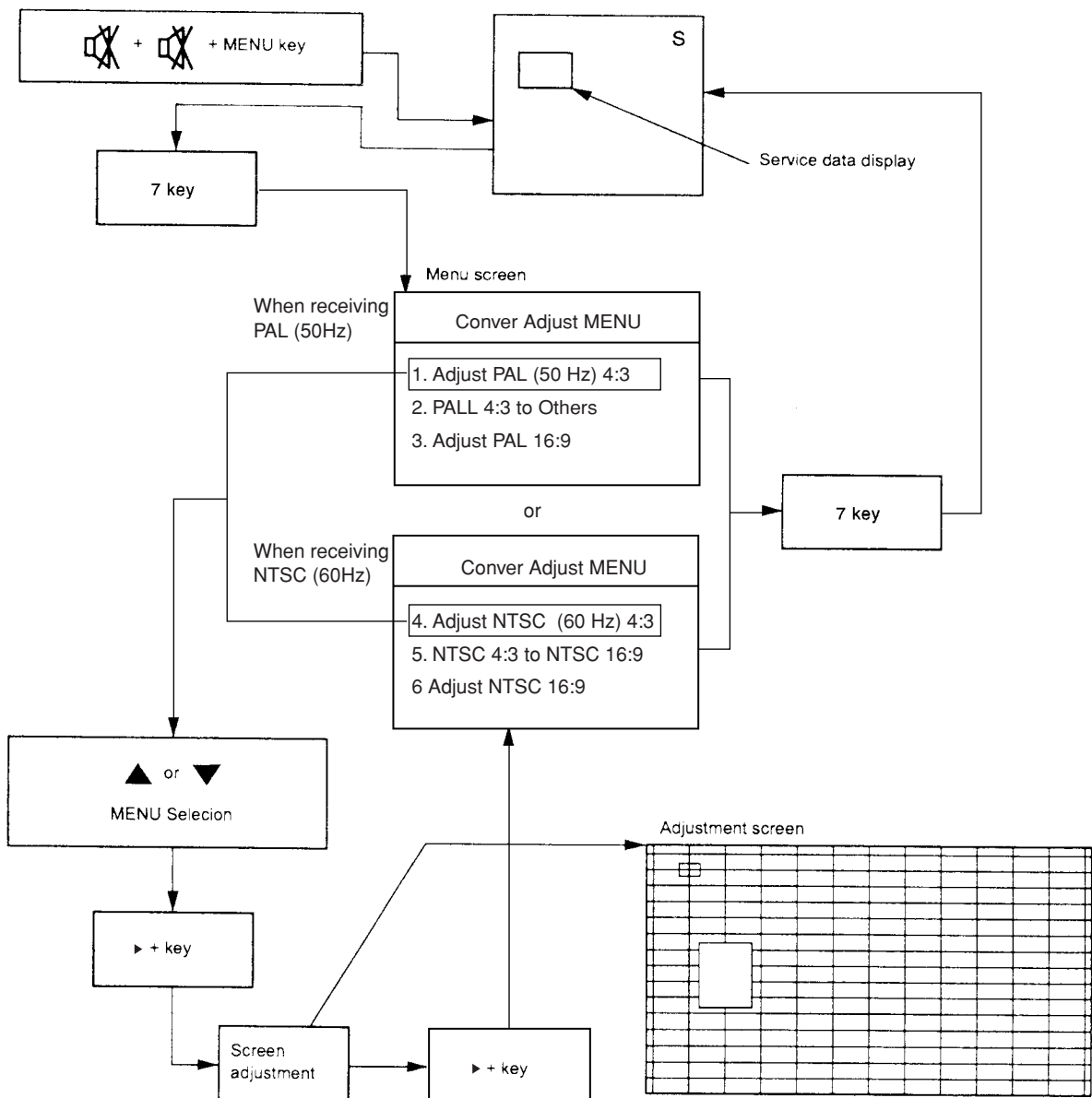
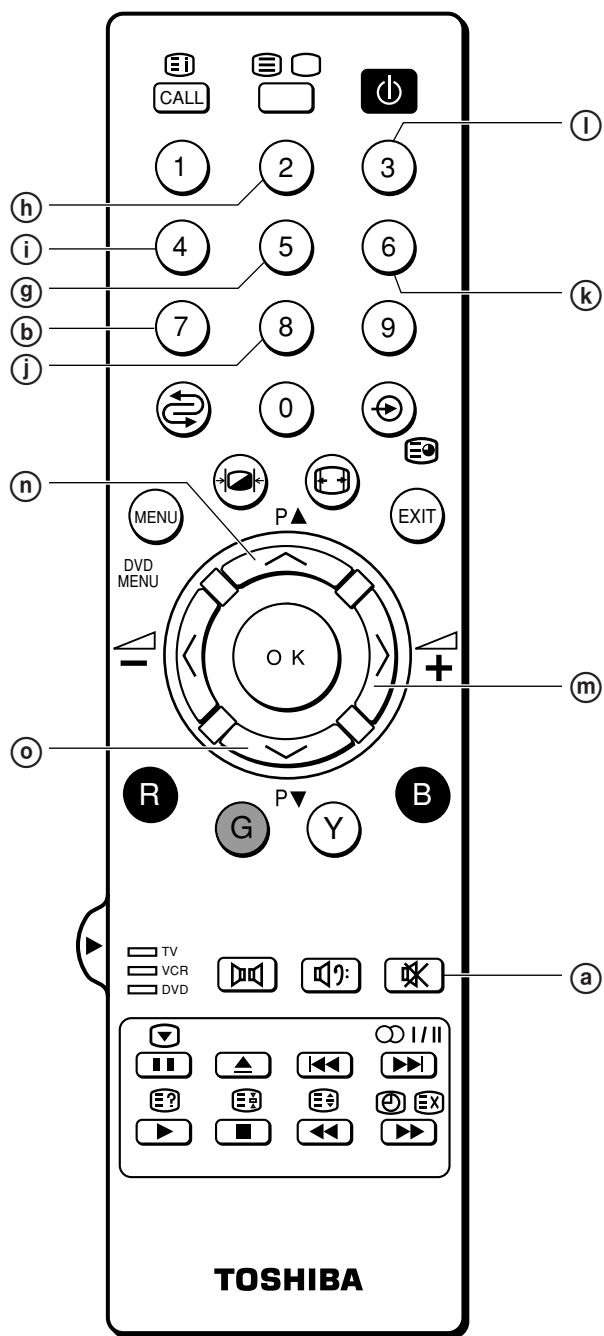

Fig. 1

1-2. Remote Control Key



- (a) key ..... Push this key twice and the set console menu key to enter the service mode.
- (b) 7 key ..... Push 7 key to enter and cancel the convergence menu.
- (g) 5 key ..... Cursor shift / data change mode change-over.
- (h) 2 key ..... Cursor up / adjusting point up.
- (i) 4 key ..... Cursor left / adjusting point left
- (j) 8 key ..... Cursor down / adjusting point down
- (k) 6 key ..... Cursor right / adjusting point right
- (l) 3 key ..... Cursor colour change (Adjusting colour selection).
- (m) key ..... Execution key on convergence menu.
- (n) key ..... Up key on convergence menu.
- (o) key ..... Down key on convergence menu.

Fig. 2



## 2. Picture

a) 50 Hz mode (PAL) . . . . Correcting point: Horizontal 8 × Vertical 8 (Arrow marks denote correcting point)

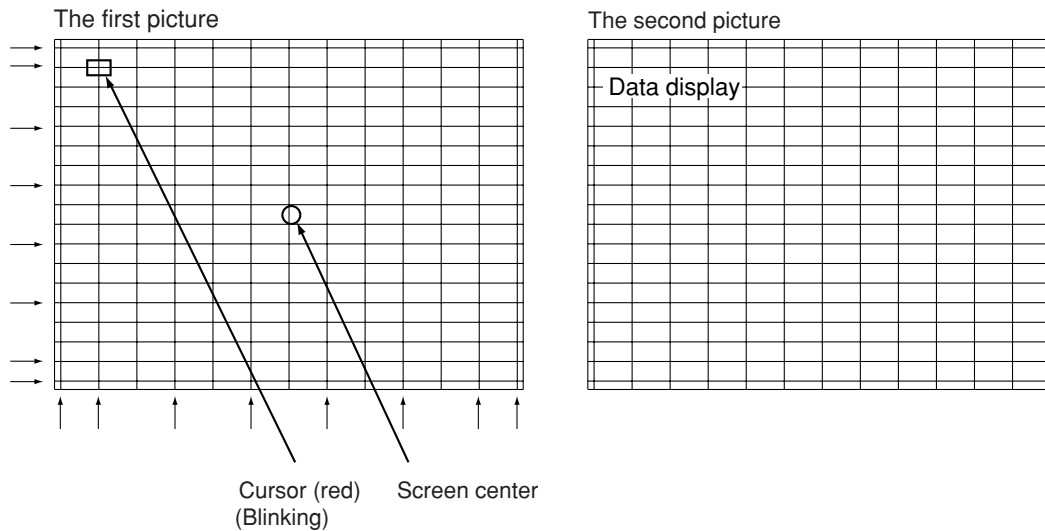

### The first picture

Crosshatch pattern. Pattern colors are three color display. Cursor is blinking in red. When changed, condition is last memory state.

Cursor is ..... Data change mode in lighting,  
Cursor shifting mode in blinking.

Display color shows the color that data change is possible.  
(Note: Red is displayed in yellow.)

### The second picture

When entering from the first picture to the second picture, correcting wave of convergence is muted for one second. During this period, the changed data is transferred from RAM Q701 to E2PROM Q711, and saved.

The second picture is indicated with data on top left of the first picture, therefore, convergence cannot be adjusted by this picture.

### Caution:

- Receive suitable signal for adjustment. Centering of green picture can be done in 50 Hz mode (PAL).
- Centering of 60 Hz mode (NTSC) can be adjusted by convergence adjustment. Besides, decide the center by cross pattern of static convergence in menu, and adjust convergence from center to circumference.

**b) 60 Hz mode (NTSC) . . . Correcting point: Horizontal 8 × Vertical 7 (Arrow marks denote correcting point)**

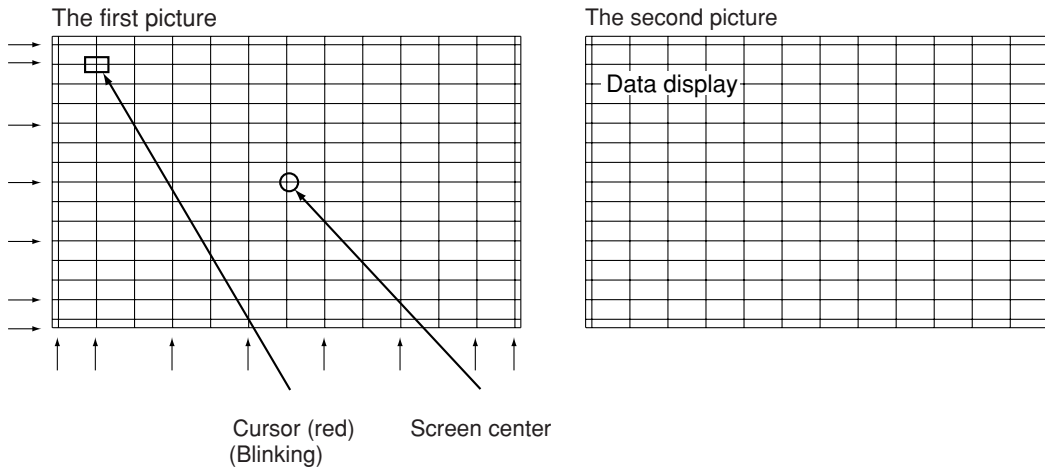

**The first picture**

Crosshatch pattern. Pattern colors are three color display. Cursor is blinking in red. When changed, condition is last memory state.

Cursor is ..... Data change mode in lighting,  
Cursor shifting mode in blinking.

Display color shows the color that data change is possible.

**The second picture**

When entering from the first picture to the second picture, correcting wave of convergence is muted for one second.

During this period, the changed data is transferred from RAM Q701 to E<sup>2</sup>PROM Q711, and saved.

The second picture is indicated with data on top left of the first picture, therefore, convergence cannot be adjusted by this picture.

**Caution:**

- Receive suitable signal for adjustment. Decide the center by cross pattern of static convergence in menu, and adjust convergence from center to circumference.

### 3. ADJUSTING PICTURE DIMENSION (GREEN PICTURE)

[4:3]

#### 1.50 Hz mode (PAL)

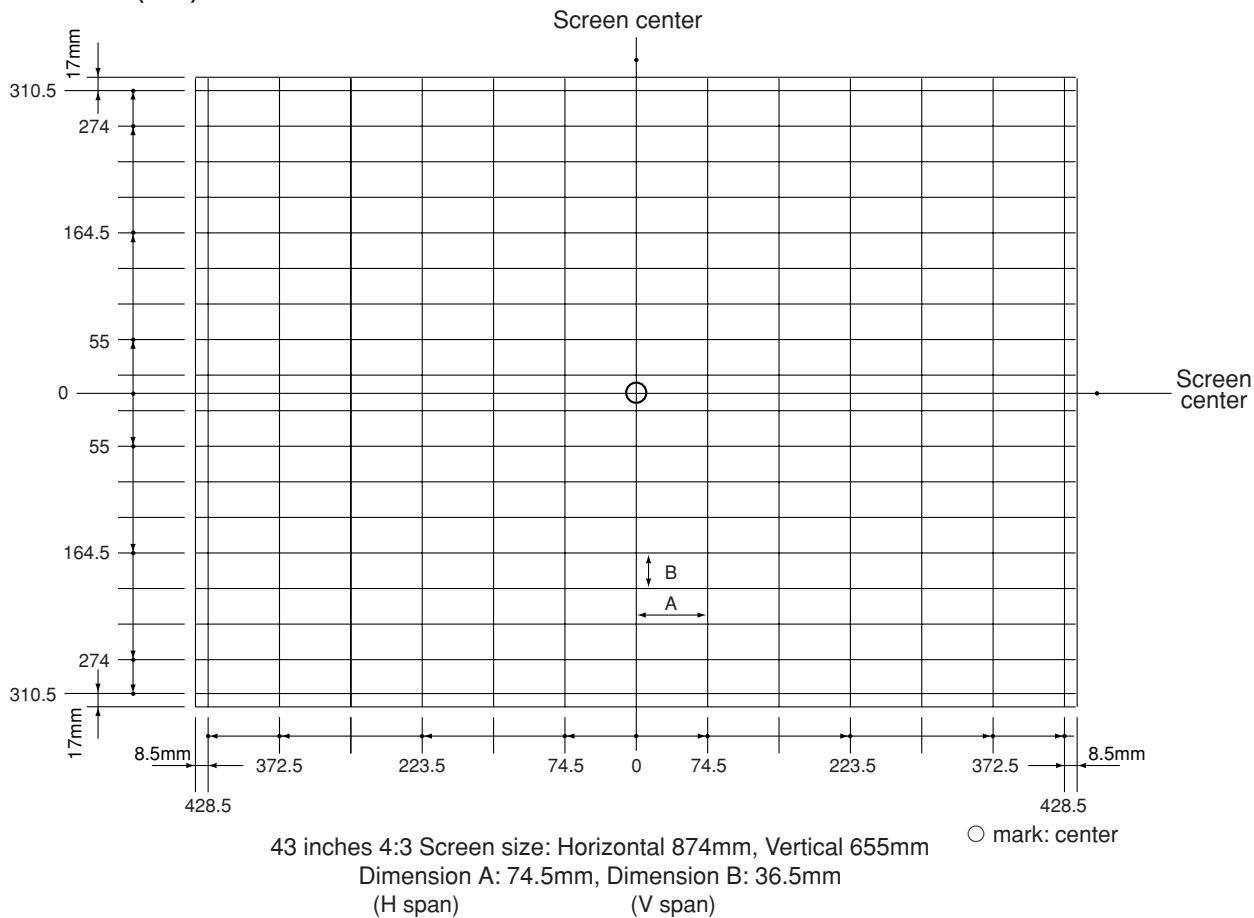

#### 2. 60Hz mode (NTSC)

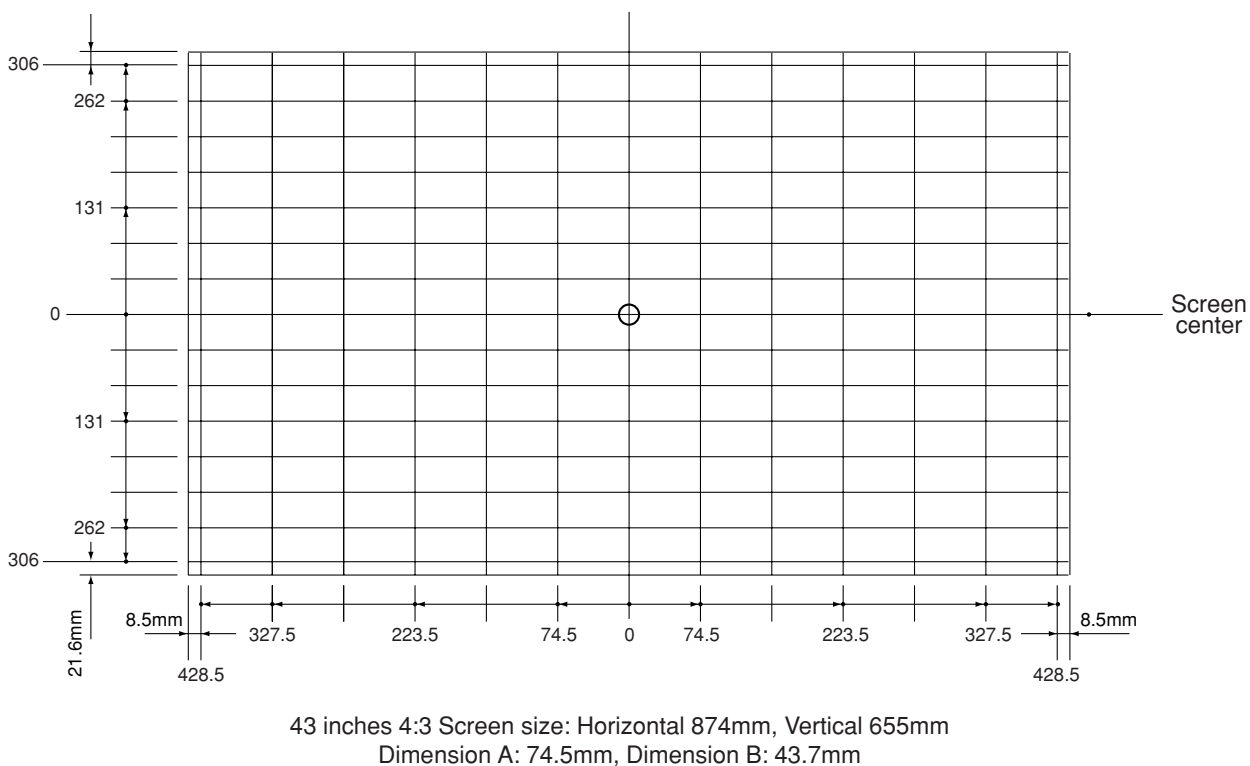

4. ADJUSTING PICTURE DIMENSION (GREEN PICTURE)

[16:9]

1.50 Hz mode (PAL)

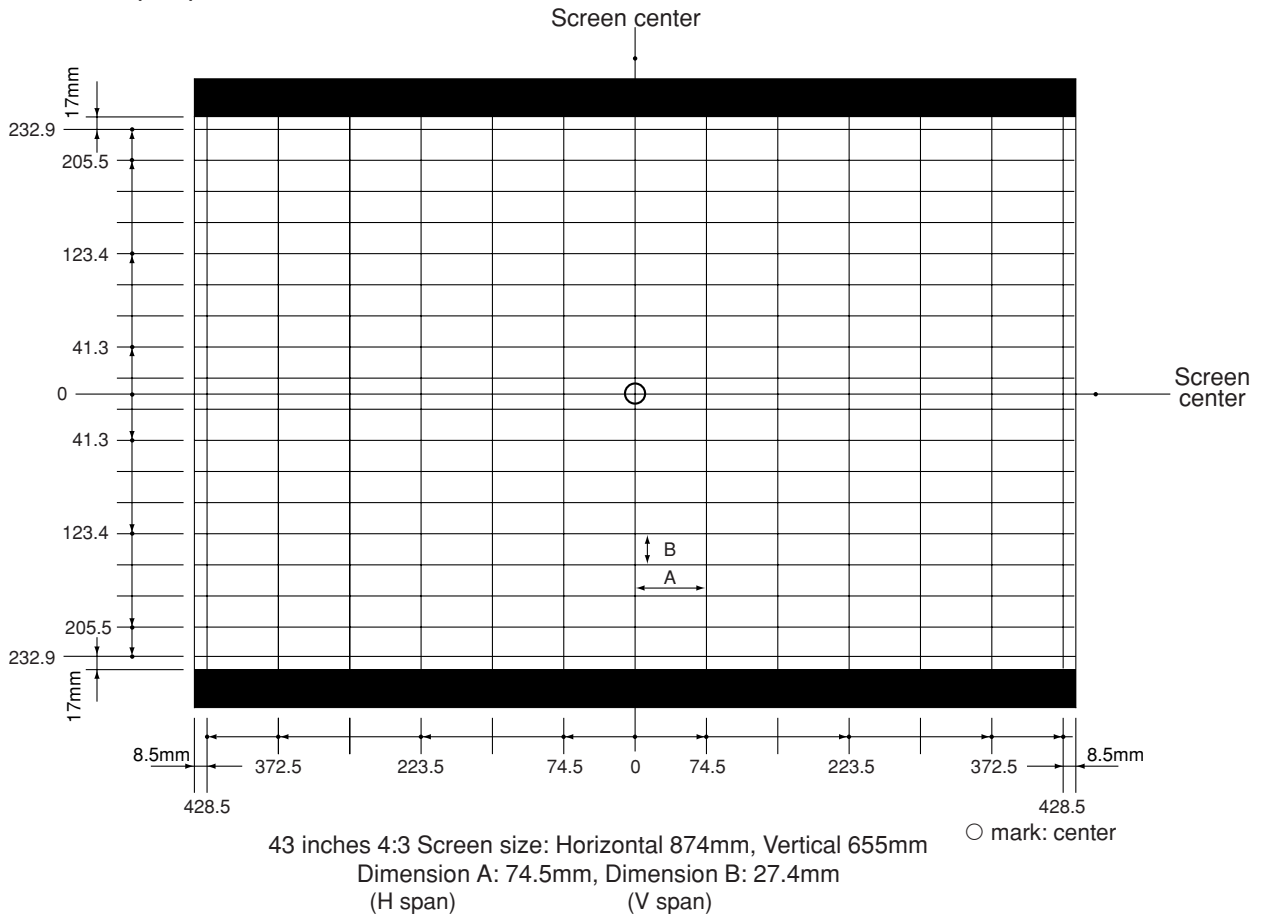

2. 60Hz mode (NTSC)

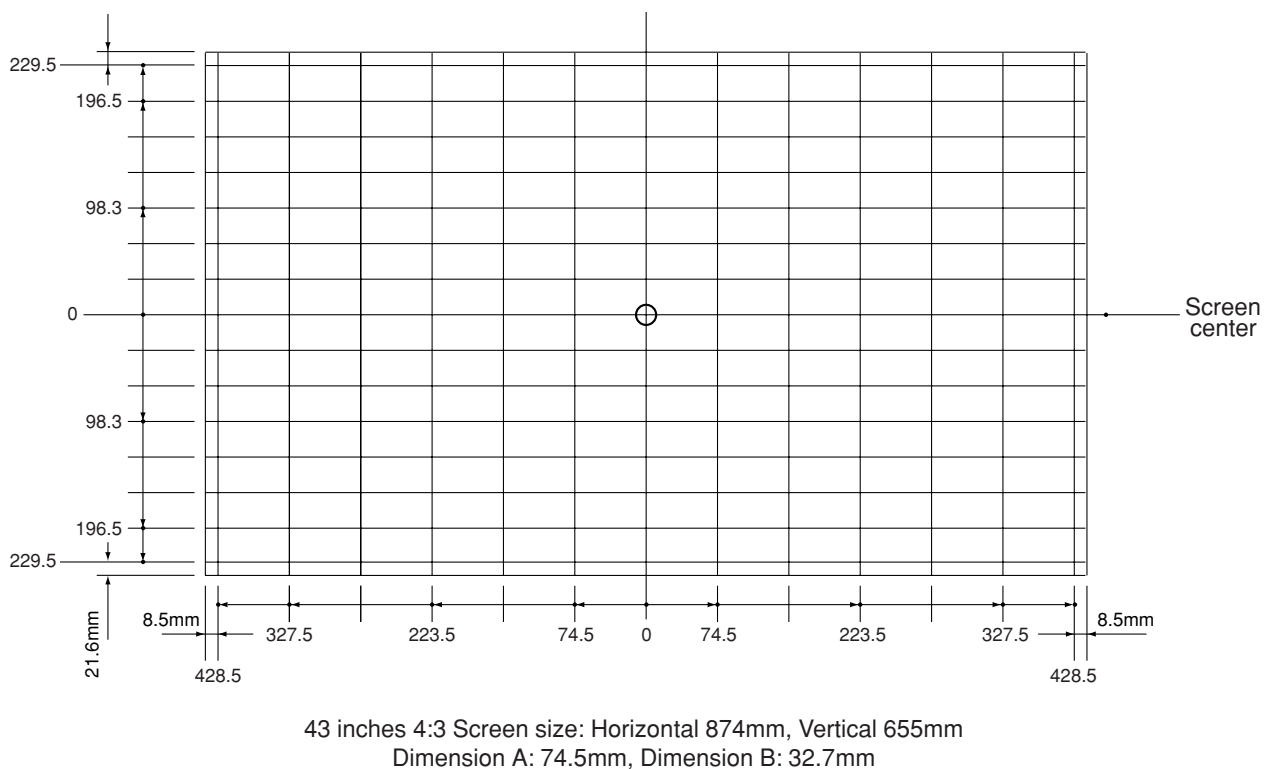

## SCREEN AND MIRROR ALIGNMENTS

### ASSEMBLING AND MOUNTING OF FRONT SCREEN

\* Please refer to MECHANICAL DISASSEMBLY page 32.

### CLEANING OF LENS AND MIRROR

**CAUTION :** Do not hold the optical system parts (lens and mirror) with bare hand to avoid finger-prints on the surface of those parts.

#### HOW TO CLEAN LENS AND MIRROR

1. Be sure to remove sand dust with an air brush, etc.
2. When it is stained slightly, breathe upon it and wipe away with the specified cleaning cloth.  
For other stains than the above, wipe the stains away with the specified cloth into which a cleaning liquid has been soaked.

Cleaning liquid ..... **LENS LUSTER** (Manufactured by Edmund Scientific Co.), etc.

#### HOW TO CLEAN SCREEN

When cleaning the screen, use a soft cloth so as not to damage the screen.

1. Wipe the stain away with a diluted neutral detergent soaked cloth.
2. Wipe the detergent away with a water soaked cloth.
3. Wipe the screen with a dry cloth to remove moisture on the screen.

**Note :** Absolutely do not use alcohol, benzine, thinner, etc. for cleaning in order not to wipe away the black print on the surface.

## CIRCUIT CHECKS

### HIGH VOLTAGE CHECK

**CAUTION:** There is no HIGH VOLTAGE ADJUSTMENT on this chassis. Checking should be done following the steps below.

1. Connect an accurate high voltage meter to the anode of the picture tube.
2. Turn on the receiver. Set the BRIGHTNESS and CONTRAST to minimum (zero beam current).
3. High voltage must be measured below (B) kV.

Refer to table-1 for high voltage (B).  
(See SETTING & ADJUSTING DATA on page 23)

4. Vary the BRIGHTNESS to both extremes to be sure the high voltage does not exceed the limit under any conditions.

### CAUTION:

When the following parts fail, check the High Voltage after replacing.

Location No.	Name	Name
T461	Flyback Trans.	TFB3091BH
C440	Capacitor	1500pF, $\pm 3\%$
C443	Capacitor	4700pF, $\pm 3\%$
C444	Capacitor	3600pF, $\pm 3\%$
C467	Capacitor	12000pF, $\pm 5\%$
C468	Capacitor	12000pF, $\pm 5\%$

### ANODE VOLTAGE MEASURING METHOD

**CAUTION:** Take extra precaution when measuring this high voltage. High voltages are also present in surrounding circuit boards (CRT DRIVE assembly, DEFLECTION assembly, and POWER SUPPLY assembly).

1. Disconnect the FBT anode cable as outlined below. Measure high voltage at the point where the cable enters the FBT.
2. Holding the rubber cover firmly, turn it counterclockwise and check that the lock has been disengaged. (See Fig. b on page 8.)
3. Determine the extent of the rubber cover before disconnecting the cable.
4. Pull straight up the anode cable to disconnect.
5. When reconnecting the cable, proceed in the reverse order.  
After reconnecting, tug on the cable to check that it is secure.

## CHAPTER 2 SPECIFIC INFORMATIONS

### SETTING & ADJUSTING DATA

#### 【 SAFETY INSTRUCTIONS 】

		43"/50"
HIGH VOLTAGE AT ZERO BEAM:	(A)	31.3 kV
MAX HIGH VOLTAGE:	(B)	33.3 kV
AC VOLTAGE	(C)	220~240 V

Table-1

#### 【 SERVICE MODE 】

##### ADJUSTING ITEMS AND DATAS IN THE SERVICE MODE:

Item	Adjustment	Reference data
RCUT	R CUTOFF (B/W)	40H
GCUT	G CUTOFF (B/W)	40H
BCUT	B CUTOFF (B/W)	40H
RDRV	R DRIVE	40H
BDRV	B DRIVE	40H
BRTC	SUB BRIGHT CEN	40H
COLP	SUB COLOR CEN PAL	3CH
COLS	SUB COLOR CEN SECAM	3CH
SCNT	SUB CONTRAST	00H
SRY	SECAM R-Y	08H
SBY	SECAM B-Y	08H
HIT	HEIGHT	5CH
VLIN	V-LINEARITY	08H
WID	PICTURE WIDTH	22H
VCEN	V-POSITION (RASTER)	2AH

Table-2

#### 【 DESIGN MODE 】

##### ADJUSTING ITEMS AND DATAS IN THE DESIGN MODE:

Item	Name of adjustment	Preset Data (43")	Remarks
OPT0	OPTION 0	80H	
OPT1	OPTION 1	4AH	
OPT2	OPTION 2	20H	
OPT4	OPTION 4	01H	

Table-3

# LOCATION OF CONTROLS

SPECIFIC INFORMATIONS

Front

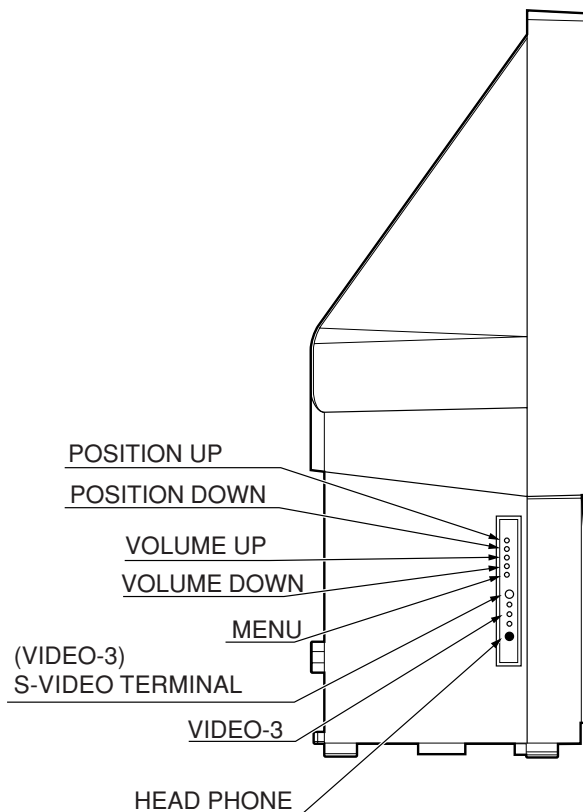
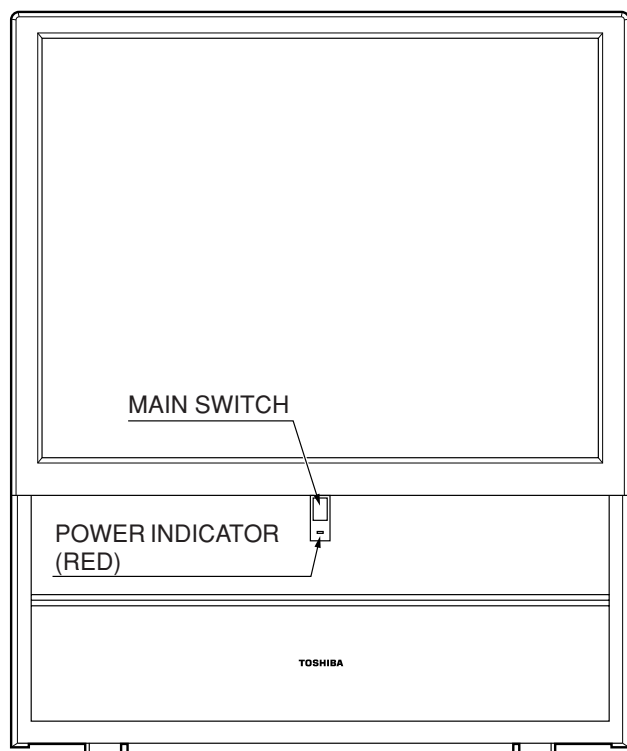

Back

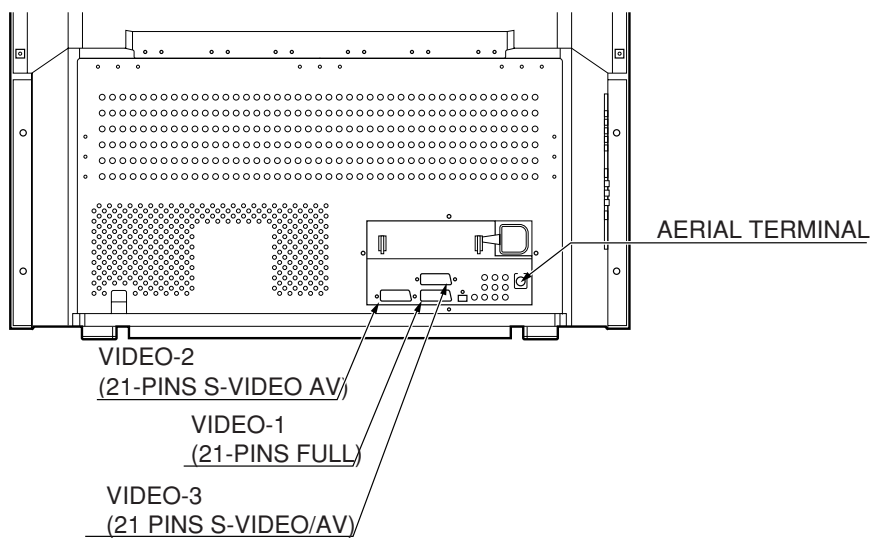



Remote Controller

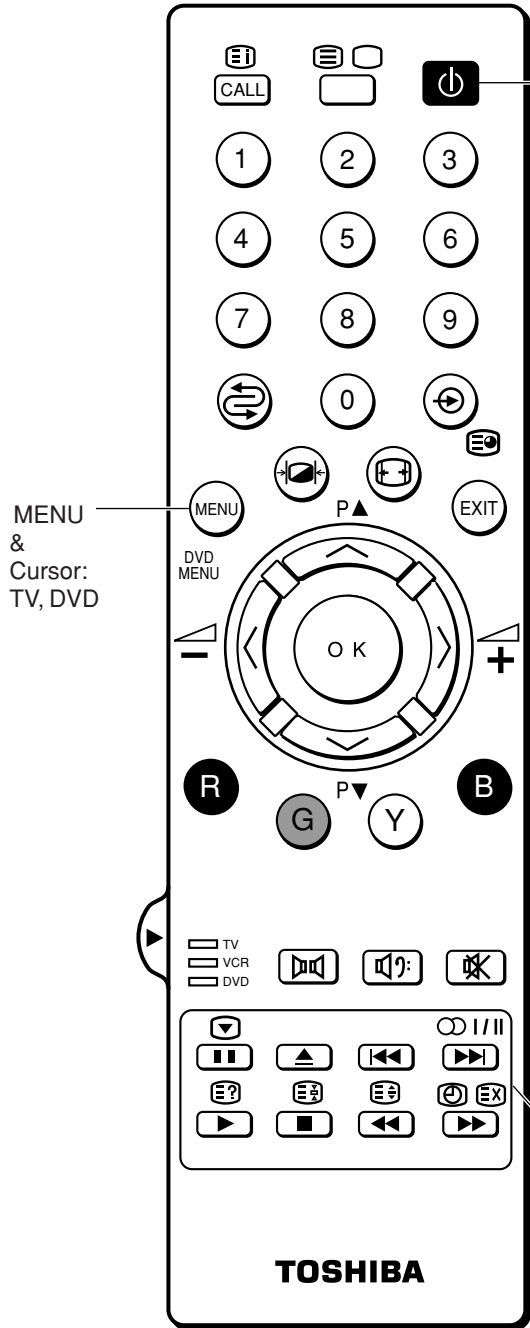

Power Key: TV, VCR, DVD

MENU & Cursor: TV, DVD

Switched TV Mode VCR Mode DVD Mode

1. TEXT Sub Function  
 <HOLD, REVEAL, F-T-B, TIME/TXCL, SUB PAGE>  
  
 ----- Only TV mode operation
  
2. VCR & DVD Common  
 <Power, Play, Stop, Pause, Eject, FF, REV, Skip - FWD, Skip - REV>
  
3. Key Name (by special characters)  
 ----- Power ON - Standby  
 ----- TEXT INDEX  
 ----- TEXT / TV  
 ----- VIDEO INPUT  
 ----- SELECTABLE PICTURE  
 ----- MUTE  
 ----- VOLUME +, -  
 ----- POSITION(CH.) Up/Down  
 ----- Size  
 ----- STILL PICTURE  
 ----- Sub Woofer  
 ----- SURROUND  
 ----- Stereo Bilingual  
 ----- Previous Ch.  
 ----- INFO.

# MECHANICAL DISASSEMBLY

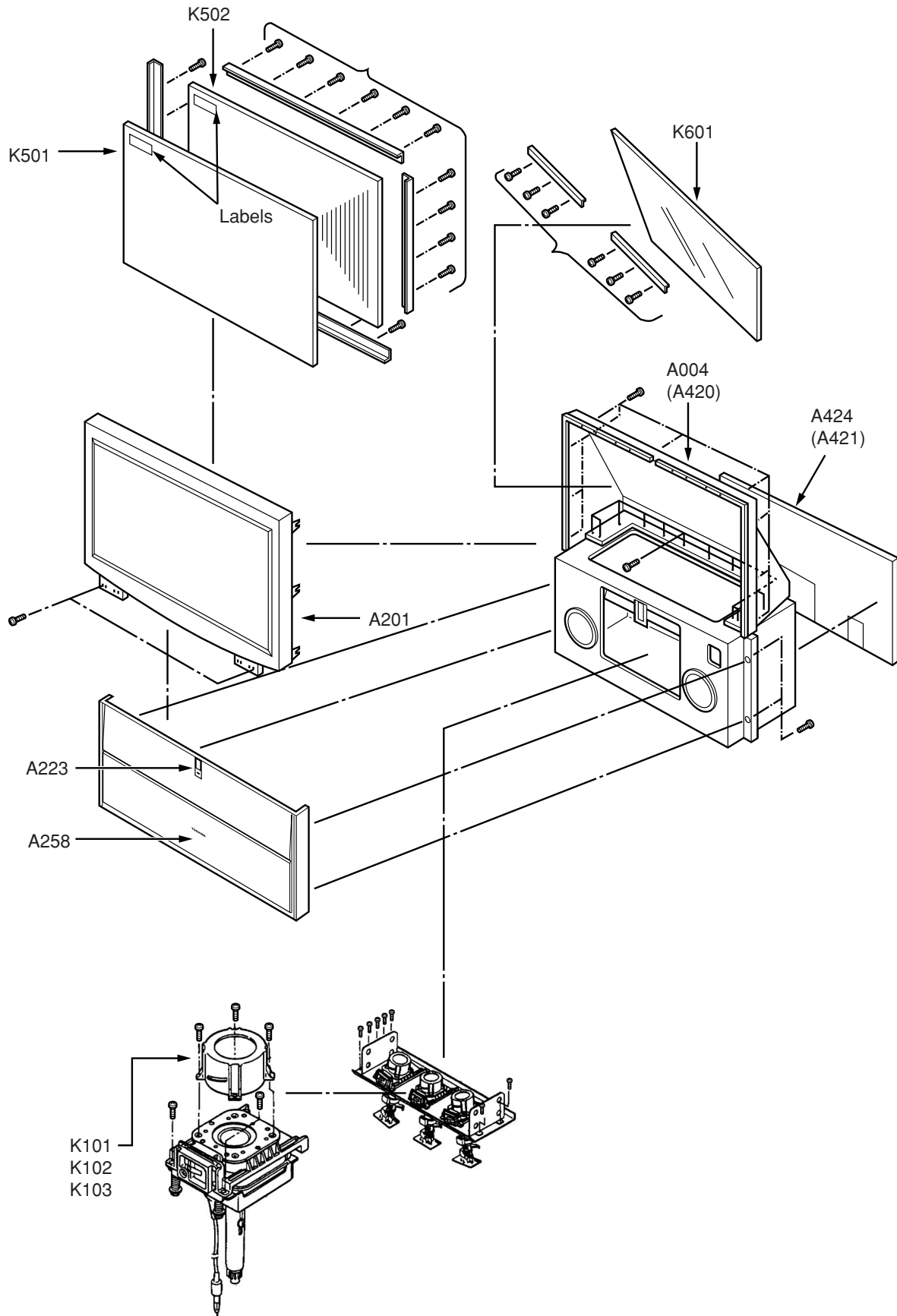

SPECIFIC INFORMATIONS

# CHASSIS AND CABINET REPLACEMENT PARTS LIST

**WARNING:** BEFORE SERVICING THIS CHASSIS, READ THE "X-RAY RADIATION PRECAUTION", "SAFETY PRECAUTION" AND "PRODUCT SAFETY NOTICE" ON PAGE 3 OF THIS MANUAL.

**CAUTION:** The international hazard symbols "⚠" in the schematic diagram and the parts list designate components which have special characteristics important for safety and should be replaced only with types identical to those in the original circuit or specified in the parts list. The mounting position of replacements is to be identical with originals. Before replacing any of these components, read carefully the PRODUCT SAFETY NOTICE . Do not degrade the safety of the receiver through improper servicing.

**NOTICE:**

- The part number must be used when ordering parts, in order to assist in processing, be sure to include the Model number and Description.
- The PC board assembly with \*mark is no longer available after the end of the production.

**ABBREVIATIONS:**

Capacitors ..... CD : Ceramic Disk      PF : Plastic Film      EL : Electrolytic  
 Resistors ..... CF : Carbon Film      CC : Carbon Composition      MF : Metal Film  
                          OMF : Oxide Metal Film      VR : Variable Resistor      FR : Fusible Resistor

(All CD and PF capacitors are ±5%, 50V and all resistors, ±5%, 1/6W unless otherwise noted.)

**Models : 43VJ22P**

Location No.	Parts No.	Description
<b>CAPACITORS</b>		
C101	24794470	ELECTORLYTIC, 16V 47UF M
C102	24109103	CERAMIC CHIP, 50V B 0.01UF K
C103	24793221	ELECTROLYTIC, 10V 220UF M
C104	24109103	CERAMIC CHIP, 50V B 0.01UF K
C105	24797100	ELECTROLYTIC, 50V 10UF M
C106	24109102	CERAMIC CHIP, 50V B 1000PF K
C107	24109103	CERAMIC CHIP, 50V B 0.01UF K
C108	24794101	ELECTROLYTIC, 16V 100UF M
C109	24109103	CERAMIC CHIP, 50V B 0.01UF K
C110	24109103	CERAMIC CHIP, 50V B 0.01UF K
C111	24109103	CERAMIC CHIP, 50V B 0.01UF K
C112	24503049	PLASTIC FILM, 63V 0.47UF J
C113	24109103	CERAMIC CHIP, 50V B 0.01UF K
C114	24109103	CERAMIC CHIP, 50V B 0.01UF K
C115	24109103	CERAMIC CHIP, 50V B 0.01UF K
C116	24109103	CERAMIC CHIP, 50V B 0.01UF K
C117	24105470	CERAMIC CHIP, 50V CH 47PF J
C118	24794101	ELECTROLYTIC, 16V 100UF M
C119	24793101	ELECTROLYTIC, 10V 100UF M
C120	24109103	CERAMIC CHIP, 50V B 0.01UF K
C122	24109103	CERAMIC CHIP, 50V B 0.01UF K
C123	24100102	CERAMIC CHIP, 50V F 1000PF Z
C124	24797478	ELECTROLYTIC, 50V 0.47UF M
C125	24669479	ELECTROLYTIC, 50V 4.7UF M 3A
C126	24590472	PLASTIC FILM, 50V 4700PF J
C127	24797478	ELECTROLYTIC, 50V 0.47UF M
C128	24794100	ELECTROLYTIC, 16V 10UF M
C129	24794100	ELECTROLYTIC, 16V 10UF M
C130	24109103	CERAMIC CHIP, 50V B 0.01UF K
C140	24109103	CERAMIC CHIP, 50V B 0.01UF K
C160	24567224	PLASTIC FILM, 50V 0.22UF J
C170	24567104	PLASTIC FILM, 50V 0.1UF J
C202	24109103	CERAMIC CHIP, 50V B 0.01UF K
C204	24797479	ELECTROLYTIC, 50V 4.7UF M
C205	24092538	CERAMIC CHIP, 10V F 1UF Z
C206	24794470	ELECTORLYTIC, 16V 47UF M
C214	24503047	PLASTIC FILM, 63V 0.33UF J
C307	24503049	PLASTIC FILM, 63V 0.47UF J
C309	24591102	PLASTIC FILM, 50V 1000PF J
C310	24667101	ELECTROLYTIC, 25V 100UF M 3A
C311	24567103	PLASTIC FILM, 50V 0.01UF J

Location No.	Parts No.	Description
C314	24092730	CERAMIC CHIP, 16V B 0.1UF K
C320	24669101	ELECTROLYTIC, 50V 100UF M 3A
C321	24669101	ELECTROLYTIC, 50V 100UF M 3A
C324	24669101	ELECTROLYTIC, 50V 100UF M 3A
C325	24503045	PLASTIC FILM, 63V 0.22UF J
C327	24503045	PLASTIC FILM, 63V 0.22UF J
C329	24669100	ELECTROLYTIC, 50V 10UF M 3A
C330	24085946	ELECTROLYTIC, NONPOLAR, 16V 10UF M 3A
C332	24669221	ELECTROLYTIC, 50V 220UF M 3A
C333	24693473	PLASTIC FILM, 100V 0.047UF J
C335	24503041	PLASTIC FILM , 63V 0.1UF J
C338	24666330	ELECTROLYTIC, 16V 33UF M 3A
C340	24666330	ELECTROLYTIC, 16V 33UF M 3A
C370	24669229	ELECTROLYTIC, 50V 2.2UF M 3A
C371	24092730	CERAMIC CHIP, 16V B 0.1UF K
C401	24214821	CERAMIC DISC, 500V B 820PF K
C402	24214391	CERAMIC DISC, 500V B 390PF K
C404	24212152	CERAMIC DISC, 50V B 1500PF K
C405	24567124	PLASTIC FILM, 50V 0.12UF J
C406	24678100	ELECTROLYTIC, 200V 10UF M 3A
C410	24667102	ELECTROLYTIC, 25V 1000UF M 3A
C412	24828683	PLASTIC FILM, 200V 68000PF J
C415	24092484	CERAMIC DISC, 2KV B 1500PF K
C416	24828333	PLASTIC FILM, 200V 33000PF J
C417	24679229	ELECTROLYTIC, 250V 2.2UF M 3A
C423	24503293	PLASTIC FILM CF92 T 400V R39UF J
C426	24211222	CERAMIC DISC, 2KV B 2200PFK
C432	24567223	PLASTIC FILM, 50V 0.22UF J
C433	24567473	PLASTIC FILM, 50V 47000PF J
C440	24503063	PLASTIC FILM, 1800VH 1500PF H
C443	24503146	PLASTIC FILM CF92 T 1500VH 4700PF H
C444	24082943	PLASTIC FILM, 1500VH 3600PF H
C445	24828473	PLASTIC FILM, 200V 47000PF J
C446	24679330	ELECTROLYTIC, 250V 33UF M 3A
C448	24073118	ELECTROLYTIC, 160V 33UF M
C449	24214221	CERAMIC DISC, 500V B 220PF K
C460	24679479	ELECTROLYTIC, 250V 4.7UF M 3A
C463	24567333	PLASTIC FILM, 50V 33000PF J
C464	24503343	PLASTIC FILM, 100V 3.3UF K
C465	24567103	PLASTIC FILM, 50V 0.01UF J
C466	24591472	PLASTIC FILM, 50V 4700PF J
C467	24820123	PLASTIC FILM, 630V 0.012UF J

Location No.	Parts No.	Description
C468	24820123	PLASTIC FILM, 630V 0.012UF J
C481	24666101	ELECTROLYTIC, 16V 100UF M 3A
C482	24591223	PLASTIC FILM, 50V 0.022UF J
C483	24591223	PLASTIC FILM, 50V 0.022UF J
C484	24591102	PLASTIC FILM, 50V 1000PF J
C491	24666100	ELECTROLYTIC, 10V 10UF M 3A
C497	24503049	PLASTIC FILM, 63V 0.47UF J
C498	24669479	ELECTROLYTIC, 50V 4.7UF M 3A
C501	24100104	CERAMIC CHIP, 25V F 0.1UF Z
C502	24092743	CERAMIC CHIP, 10V F 470NF Z
C503	24794470	ELECTROLYTIC, 16V 47UF M
C504	24109103	CERAMIC CHIP, 50V B 0.01UF K
C511	24100104	CERAMIC CHIP, 25V F 0.1UF Z
C512	24100104	CERAMIC CHIP, 25V F 0.1UF Z
C513	24100104	CERAMIC CHIP, 25V F 0.1UF Z
C514	24794470	ELECTROLYTIC, 16V 47UF M
C516	24105110	CERAMIC CHIP, 50V CH 11PF J
C517	24092734	CERAMIC CHIP, 16V F 0.22UF Z
C522	24109103	CERAMIC CHIP, 50V B 0.01UF K
C524	24109103	CERAMIC CHIP, 50V B 0.01UF K
C526	24109222	CERAMIC CHIP, 50V B 2200PF K
C540	24100104	CERAMIC CHIP, 25V F 0.1UF Z
C541	24100104	CERAMIC CHIP, 25V F 0.1UF Z
C542	24100104	CERAMIC CHIP, 25V F 0.1UF Z
C601	24669010	ELECTROLYTIC, 50V 1.0UF M 3A
C602	24669010	ELECTROLYTIC, 50V 1.0UF M 3A
C603	24591102	PLASTIC FILM, 50V 1000PF J
C604	24591102	PLASTIC FILM, 50V 1000PF J
C605	24669010	ELECTROLYTIC, 50V 1.0UF M 3A
C606	24669010	ELECTROLYTIC, 50V 1.0UF M 3A
C607	24667470	ELECTROLYTIC, 25V 47UF M 3A
C608	24667470	ELECTROLYTIC, 25V 47UF M 3A
C609	24667470	ELECTROLYTIC, 25V 47UF M 3A
C610	24669479	ELECTROLYTIC, 50V 4.7UF M 3A
C612	24669102	ELECTROLYTIC, 50V 1000UF M 3A
C613	24503042	PLASTIC FILM, 63V 0.12UF J
C614	24503042	PLASTIC FILM, 63V 0.12UF J
C615	24669102	ELECTROLYTIC, 50V 1000UF M 3A
C616	24669102	ELECTROLYTIC, 50V 1000UF M 3A
C617	24669220	ELECTROLYTIC, 50V 22UF M 3A
C618	24669478	ELECTROLYTIC, 50V 0.47UF M 3A
C619	24794471	ELECTROLYTIC, 16V 470UF M
C621	24669229	ELECTROLYTIC, 50V 2.2UF M 3A
C622	24591223	PLASTIC FILM, 50V 0.022UF J
C623	24797479	ELECTROLYTIC, 50V 4.7UF M
C624	24795101	ELECTROLYTIC, 25V 100UF M
C625	24795221	ELECTROLYTIC, 25V 220UF M
C639	24793101	ELECTROLYTIC, 10V 100UF M
C701	24105330	CERAMIC CHIP, 50V CH 33PF J
C702	24105330	CERAMIC CHIP, 50V CH 33PF J
C703	24105330	CERAMIC CHIP, 50V CH 33PF J
C704	24105330	CERAMIC CHIP, 50V CH 33PF J
C706	24100104	CERAMIC CHIP, 25V F 0.1UF Z
C707	24100104	CERAMIC CHIP, 25V F 0.1UF Z
C708	24100104	CERAMIC CHIP, 25V F 0.1UF Z
C710	24100104	CERAMIC CHIP, 25V F 0.1UF Z
C712	24105330	CERAMIC CHIP, 50V CH 33PF J
C713	24105330	CERAMIC CHIP, 50V CH 33PF J
C714	24100104	CERAMIC CHIP, 25V F 0.1UF Z
C715	24100104	CERAMIC CHIP, 25V F 0.1UF Z
C716	24100104	CERAMIC CHIP, 25V F 0.1UF Z
C719	24794101	ELECTROLYTIC, 16V 100UF M
C721	24105070	CERAMIC CHIP CC73CH 50V 7PF D
C724	24100104	CERAMIC CHIP, 25V F 0.1UF Z
C725	24100104	CERAMIC CHIP, 25V F 0.1UF Z
C726	24100104	CERAMIC CHIP, 25V F 0.1UF Z
C727	24100104	CERAMIC CHIP, 25V F 0.1UF Z

Location No.	Parts No.	Description
C730	24100104	CERAMIC CHIP, 25V F 0.1UF Z
C731	24100104	CERAMIC CHIP, 25V F 0.1UF Z
C732	24100103	CERAMIC CHIP, 50V F 0.01UF Z
C735	24092178	CERAMIC CHIP, 25V B 0.1UF K
C736	24100104	CERAMIC CHIP, 25V F 0.1UF Z
C739	24100104	CERAMIC CHIP, 25V F 0.1UF Z
C740	24100104	CERAMIC CHIP, 25V F 0.1UF Z
C741	24794470	ELECTROLYTIC, 16V 47UF M
C742	24794470	ELECTROLYTIC, 16V 47UF M
C743	24100104	CERAMIC CHIP, 25V F 0.1UF Z
C744	24100104	CERAMIC CHIP, 25V F 0.1UF Z
C745	24794470	ELECTROLYTIC, 16V 47UF M
C746	24794470	ELECTROLYTIC, 16V 47UF M
C747	24100104	CERAMIC CHIP, 25V F 0.1UF Z
C748	24100104	CERAMIC CHIP, 25V F 0.1UF Z
C749	24794470	ELECTROLYTIC, 16V 47UF M
C750	24794470	ELECTROLYTIC, 16V 47UF M
C761	24105102	CERAMIC CHIP, 25V CH 1000PF J
C762	24590562	PLASTIC FILM, 50V 5600PF J
C763	24105391	CERAMIC CHIP, 50V CH 390PF J
C765	24105102	CERAMIC CHIP, 25V CH 1000PF J
C766	24590562	PLASTIC FILM, 50V 5600PF J
C767	24105391	CERAMIC CHIP, 50V CH 390PF J
C769	24105102	CERAMIC CHIP, 25V CH 1000PF J
C770	24590562	PLASTIC FILM, 50V 5600PF J
C771	24105391	CERAMIC CHIP, 50V CH 390PF J
C772	24761221	ELECTROLYTIC CE04G 6.3V 220UF M
C773	24105102	CERAMIC CHIP, 25V CH 1000PF J
C774	24590562	PLASTIC FILM, 50V 5600PF J
C775	24105391	CERAMIC CHIP, 50V CH 390PF J
C777	24105102	CERAMIC CHIP, 25V CH 1000PF J
C778	24590562	PLASTIC FILM, 50V 5600PF J
C779	24105391	CERAMIC CHIP, 50V CH 390PF J
C781	24105102	CERAMIC CHIP, 25V CH 1000PF J
C782	24590562	PLASTIC FILM, 50V 5600PF J
C783	24105391	CERAMIC CHIP, 50V CH 390PF J
C784	24105821	CERAMIC CHIP, 25V CH 820PF J
C785	24105821	CERAMIC CHIP, 25V CH 820PF J
C786	24105821	CERAMIC CHIP, 25V CH 820PF J
C787	24105821	CERAMIC CHIP, 25V CH 820PF J
C788	24105821	CERAMIC CHIP, 25V CH 820PF J
C789	24105821	CERAMIC CHIP, 25V CH 820PF J
C795	24761221	ELECTROLYTIC CE04G 6.3V 220UF M
C798	24763101	ELECTROLYTIC, 16V 100UF M
C799	24763101	ELECTROLYTIC, 16V 100UF M
△ C801	24503055	PLASTIC FILM, AC275V 0.22UF M
△ C802	24092569	CERAMIC DISC, AC250V E 2200PF M
C803	24092569	CERAMIC DISC, AC250V E 2200PF M
C804	24092570	CERAMIC DISC, AC250V E 3300PF M
C805	24092569	CERAMIC DISC, AC250V E 2200PF M
C806	24092569	CERAMIC DISC, AC250V E 2200PF M
C808	24503054	MT PLA AC275V 0.1UF M
C810	24073121	400V 560M 20KH LLQ2G561MHSRTL
△ C811	24092281	CERAMIC DISC, AC250V E 4700PF
C813	24092281	CERAMIC DISC, AC250V E 4700PF
C814	24503115	PLASTIC FILM CQ92 T 800V 22000PF J
C820	24503055	PLASTIC FILM, AC275V 0.22UF M
C821	24073098	ELECTROLYTIC, 450V 4.7UF M 3A
C823	24667221	ELECTROLYTIC, 25V 220UF M 3A
C824	24667221	ELECTROLYTIC, 25V 220UF M 3A
C829	24214103	CERAMIC DISC, 500V B 10000PF K
C830	24669100	ELECTROLYTIC, 50V 10UF M 3A
C831	24073037	ELECTROLYTIC, 16V 47UF M 3A
C831	24503041	PLASTIC FILM, 63V 0.1UF J
C834	24669100	ELECTROLYTIC, 50V 10UF M 3A
C835	24073015	ELECTROLYTIC, 10V 47UF M 3A
C840	24667101	ELECTROLYTIC, 25V 100UF M 3A

Location No.	Parts No.	Description
C841	24617026	ELECTROLYTIC, 16V 820UF M
C842	24669220	ELECTROLYTIC, 50V 22UF M 3A
C857	24667332	ELECTROLYTIC, 25V 3300UF M 3A
C858	24667332	ELECTROLYTIC, 25V 3300UF M 3A
C863	24503045	PLASTIC FILM, 63V 0.22UF J
C864	24092474	CERAMIC DISC, 2KV B 220PF K
C866	24503049	PLASTIC FILM, 63V 0.47UF J
C867	24591682	PLASTIC FILM, 50V 6800PF J
C868	24668470	ELECTROLYTIC, 35V 47UF M 3A
C869	24678229	ELECTROLYTIC, 200V 2.2UF M 3A
C870	24503122	PLASTIC FILM CQ92 T 800V 82000PF J
C871	24092484	CERAMIC DISC, 2KV B 1500PF K
C872	24092474	CERAMIC DISC, 2KV B 220PF K
C873	24503045	PLASTIC FILM, 63V 0.22UF J
C875	24212471	CERAMIC DISC, 50V B 470PF K
C876	24503049	PLASTIC FILM, 63V 0.47UF J
C879	24073081	ELECTROLYTIC, 50V 1.0UF M 3A
C880	24092338	CERAMIC DISC, 2KV R 270PF K
C881	24092338	CERAMIC DISC, 2KV R 270PF K
C884	24086939	ELECTROLYTIC, 200V 330UF M22B
C890	24669222	ELECTROLYTIC, 50V 2200UF M 3A
C891	24082229	PLASTIC FILM, 250V 0.1UF D
C894	24666222	ELECTROLYTIC, 16V 2200UF M 3A
C898	24503041	PLASTIC FILM , 63V 0.1UF J
C901	24211102	CERAMIC DISC, 2KV B 1000PF K
C902	24794100	ELECTROLYTIC, 16V 10UF M
C903	24232103	CERAMIC DISC, 50V F 0.01UF Z
C904	24436681	CERAMIC DISC, 50V SL 680PF J
C905	24214102	CERAMIC DISC, 500V B 1000PF K
C911	24211102	CERAMIC DISC, 2KV B 1000PF K
C912	24794100	ELECTROLYTIC, 16V 10UF M
C913	24232103	CERAMIC DISC, 50V F 0.01UF Z
C914	24436821	CERAMIC DISC, 50V SL 820PF J
C915	24679330	ELECTROLYTIC, 250V 33UF M 3A
C916	24794101	ELECTROLYTIC, 16V 100UF M
C921	24211102	CERAMIC DISC, 2KV B 1000PF K
C922	24794100	ELECTROLYTIC, 16V 10UF M
C924	24232103	CERAMIC DISC, 50V F 0.01UF Z
C926	24436681	CERAMIC DISC, 50V SL 680PF J
C961	24666101	ELECTROLYTIC, 16V 100UF M 3A
C962	24203100	ELECTORLYTIC, 16V 10UF M 7L 3A
C963	24232103	CERAMIC DISC, 50V F 0.01UF Z
C964	24591104	PLASTIC FILM, 50V 0.1UF J
C4401	24109153	CERAMIC CHIP, 50V B 0.015UF K
C4402	24797229	ELECTROLYTIC, 50V 2.2UF M
C4403	24092730	CERAMIC CHIP, 16V B 0.1UF K
C4404	24794102	ELECTROLYTIC, 16V 1000UF M
C4406	24092730	CERAMIC CHIP, 16V B 0.1UF K
C4408	24794101	ELECTROLYTIC, 16V 100UF M
C4409	24092730	CERAMIC CHIP, 16V B 0.1UF K
C4410	24797229	ELECTROLYTIC, 50V 2.2UF M
C4411	24105101	CERAMIC CHIP, 50V CH 100PF J
C4413	24092730	CERAMIC CHIP, 16V B 0.1UF K
C4451	24763101	ELECTROLYTIC, 16V 100UF M
C5070	24109103	CERAMIC CHIP, 50V B 0.01UF K
C5100	24794470	ELECTORLYTIC, 16V 47UF M
C7102	24105101	CERAMIC CHIP, 50V CH 100PF J
C7144	24109103	CERAMIC CHIP, 50V B 0.01UF K
C7167	24073053	ELECTROLYTIC, 25V 100UF M 3A
C7169	24109103	CERAMIC CHIP, 50V B 0.01UF K
C7174	24105331	CERAMIC CHIP, 50V CH 330PF J
C7176	24073053	ELECTROLYTIC, 25V 100UF M 3A
C7347	24667470	ELECTROLYTIC, 25V 47UF M 3A
C7349	24503041	PLASTIC FILM , 63V 0.1UF J
C7350	24667101	ELECTROLYTIC, 25V 100UF M 3A
C7351	24100104	CERAMIC CHIP, 25V F 0.1UF Z
C7718	24667101	ELECTROLYTIC, 25V 100UF M 3A

Location No.	Parts No.	Description
C7719	24667101	ELECTROLYTIC, 25V 100UF M 3A
C7720	24667101	ELECTROLYTIC, 25V 100UF M 3A
C7721	24212331	CERAMIC DISC, 50V B 330PF K
C7722	24212101	CERAMIC DISC, 50V B 100PF K
C7724	24667101	ELECTROLYTIC, 25V 100UF M 3A
C7725	24667101	ELECTROLYTIC, 25V 100UF M 3A
C7726	24212331	CERAMIC DISC, 50V B 330PF K
C7727	24212101	CERAMIC DISC, 50V B 100PF K
C7729	24212331	CERAMIC DISC, 50V B 330PF K
C7730	24212101	CERAMIC DISC, 50V B 100PF K
C7731	24667101	ELECTROLYTIC, 25V 100UF M 3A
C7732	24212331	CERAMIC DISC, 50V B 330PF K
C7733	24212101	CERAMIC DISC, 50V B 100PF K
C7735	24667101	ELECTROLYTIC, 25V 100UF M 3A
C7736	24667101	ELECTROLYTIC, 25V 100UF M 3A
C7737	24212331	CERAMIC DISC, 50V B 330PF K
C7738	24212101	CERAMIC DISC, 50V B 100PF K
C7740	24212331	CERAMIC DISC, 50V B 330PF K
C7741	24212101	CERAMIC DISC, 50V B 100PF K
C7751	24667101	ELECTROLYTIC, 25V 100UF M 3A
C7753	24503041	PLASTIC FILM , 63V 0.1UF J
C7754	24667101	ELECTROLYTIC, 25V 100UF M 3A
C7756	24667470	ELECTROLYTIC, 25V 47UF M 3A
C7757	24567104	PLASTIC FILM, 50V 0.1UF J
C7766	24669100	ELECTROLYTIC, 50V 10UF M 3A
C7796	24073034	ELECTROLYTIC, 16V 10UF M 3A
C9602	24794100	ELECTROLYTIC, 16V 10UF M
CA01	24100104	CERAMIC CHIP, 25V F 0.1UF Z
CA02	24100104	CERAMIC CHIP, 25V F 0.1UF Z
CA03	24100104	CERAMIC CHIP, 25V F 0.1UF Z
CA04	24100104	CERAMIC CHIP, 25V F 0.1UF Z
CA06	24100104	CERAMIC CHIP, 25V F 0.1UF Z
CA07	24105560	CERAMIC CHIP, 50V CH 56PF J
CA08	24105560	CERAMIC CHIP, 50V CH 56PF J
CA09	24109103	CERAMIC CHIP, 50V B 0.01UF K
CA10	24100104	CERAMIC CHIP, 25V F 0.1UF Z
CA11	24794100	ELECTROLYTIC, 16V 10UF M
CA12	24793470	ELECTROLYTIC CE04G 10V 47UF M
CA13	24109103	CERAMIC CHIP, 50V B 0.01UF K
CA14	24794100	ELECTROLYTIC, 16V 10UF M
CA15	24100104	CERAMIC CHIP, 25V F 0.1UF Z
CA16	24794100	ELECTROLYTIC, 16V 10UF M
CA17	24793470	ELECTROLYTIC CE04G 10V 47UF M
CA18	24793470	ELECTROLYTIC CE04G 10V 47UF M
CB01	24794470	ELECTORLYTIC, 16V 47UF M
CB01	24797010	ELECTROLYTIC, 50V 1UF M
CB02	24105181	CERAMIC CHIP, 50V CH 180PF J
CB03	24794330	ELECTROLYTIC, 16V 33UF M
CB04	24109472	CERAMIC CHIP, 50V B 4700PF K
CB05	24105561	CERAMIC CHIP, 50V CH 560PF J
CB06	24092538	CERAMIC CHIP, 10V F 1UF Z
CB07	24100104	CERAMIC CHIP, 25V F 0.1UF Z
CC08	24109102	CERAMIC CHIP, 50V B 1000PF K
CC09	24109103	CERAMIC CHIP, 50V B 0.01UF K
CC10	24212221	CERAMIC DISC, 50V B 220PF K
CC26	24109103	CERAMIC CHIP, 50V B 0.01UF K
CC27	24109103	CERAMIC CHIP, 50V B 0.01UF K
CC30	24105470	CERAMIC CHIP, 50V CH 47PF J
CC31	24105470	CERAMIC CHIP, 50V CH 47PF J
CC40	24109103	CERAMIC CHIP, 50V B 0.01UF K
CC47	24212332	CERAMIC DISC, 50V B 3300PF K
CC48	24212332	CERAMIC DISC, 50V B 3300PF K
CC51	24232103	CERAMIC DISC, 50V F 0.01UF Z
CC52	24232103	CERAMIC DISC, 50V F 0.01UF Z
CC60	24109223	CERAMIC CHIP, 25V B 0.022UF K
CC61	24109223	CERAMIC CHIP, 25V B 0.022UF K
CC62	24109102	CERAMIC CHIP, 50V B 1000PF K

Location No.	Parts No.	Description
CC63	24109102	CERAMIC CHIP, 50V B 1000PF K
CC64	24109223	CERAMIC CHIP, 25V B 0.022UF K
CC65	24109223	CERAMIC CHIP, 25V B 0.022UF K
CC66	24109102	CERAMIC CHIP, 50V B 1000PF K
CC67	24109102	CERAMIC CHIP, 50V B 1000PF K
CC68	24109102	CERAMIC CHIP, 50V B 1000PF K
CC69	24109102	CERAMIC CHIP, 50V B 1000PF K
CC70	24109102	CERAMIC CHIP, 50V B 1000PF K
CC71	24109102	CERAMIC CHIP, 50V B 1000PF K
CR01	24794100	ELECTROLYTIC, 16V 10UF M
CR02	24092538	CERAMIC CHIP, 10V F 1UF Z
CR03	24092538	CERAMIC CHIP, 10V F 1UF Z
CR04	24092538	CERAMIC CHIP, 10V F 1UF Z
CR05	24092538	CERAMIC CHIP, 10V F 1UF Z
CR06	24092538	CERAMIC CHIP, 10V F 1UF Z
CR07	24092538	CERAMIC CHIP, 10V F 1UF Z
CR09	24109103	CERAMIC CHIP, 50V B 0.01UF K
CR99	24100104	CERAMIC CHIP, 25V F 0.1UF Z
CS01	24797229	ELECTROLYTIC, 50V 2.2UF M
CS02	24797229	ELECTROLYTIC, 50V 2.2UF M
CS03	24797229	ELECTROLYTIC, 50V 2.2UF M
CS04	24797229	ELECTROLYTIC, 50V 2.2UF M
CS05	24797229	ELECTROLYTIC, 50V 2.2UF M
CS06	24797229	ELECTROLYTIC, 50V 2.2UF M
CS07	24797229	ELECTROLYTIC, 50V 2.2UF M
CS08	24797229	ELECTROLYTIC, 50V 2.2UF M
CS11	24794100	ELECTROLYTIC, 16V 10UF M
CS12	24794100	ELECTROLYTIC, 16V 10UF M
CS18	24794100	ELECTROLYTIC, 16V 10UF M
CS19	24794100	ELECTROLYTIC, 16V 10UF M
CS20	24797478	ELECTROLYTIC, 50V 0.47UF M
CV02	24100104	CERAMIC CHIP, 25V F 0.1UF Z
CV03	24100104	CERAMIC CHIP, 25V F 0.1UF Z
CV04	24100104	CERAMIC CHIP, 25V F 0.1UF Z
CV05	24109103	CERAMIC CHIP, 50V B 0.01UF K
CV06	24100104	CERAMIC CHIP, 25V F 0.1UF Z
CV08	24763221	ELECTROLYTIC, 16V 220UF M
CV12	24100104	CERAMIC CHIP, 25V F 0.1UF Z
CV23	24203101	ELECTROLYTIC, 16V 100UF M 7L 3A
CV24	24100104	CERAMIC CHIP, 25V F 0.1UF Z
CV25	24794220	ELECTROLYTIC, 16V 22UF M
CV26	24109473	CERAMIC CHIP, 25V B 0.047UF K
CV35	24109103	CERAMIC CHIP, 50V B 0.01UF K
CV65	24203101	ELECTROLYTIC, 16V 100UF M 7L 3A
CV66	24203101	ELECTROLYTIC, 16V 100UF M 7L 3A
CW04	24591822	PLASTIC FILM, 50V 8200PF J
CW05	24212103	CERAMIC DISC, 50V B 10000PF K
CW07	24666470	ELECTROLYTIC, 16V 47UF M 3A
CW12	24666470	ELECTROLYTIC, 16V 47UF M 3A
CW13	24709100	ELECTROLYTIC, 200V 10UF M
CW14	24436101	CERAMIC DISC, 50V SL 100PF J
CW15	24214472	CERAMIC DISC, 500C B 4700PF K
CW16	24436101	CERAMIC DISC, 50V SL 100PF J
CW17	24214472	CERAMIC DISC, 500C B 4700PF K
CW18	24666470	ELECTROLYTIC, 16V 47UF M 3A
CW19	24435560	CERAMIC DISC, 500V SL 56PF J
CW20	24709100	ELECTROLYTIC, 200V 10UF M
CW21	24794470	ELECTROLYTIC, 16V 47UF M
CW26	24212102	CERAMIC DISC, 50V B 1000PF K
<b>RESISTORS</b>		
R101	24382333	OXIDE METAL FILM, 1W 33K OHM J
R102	24011103	CHIP, METAL FILM, 1/20W 10K OHM J
R103	24011433	CHIP, METAL FILM, 1/20W 43K OHM J
R104	24011271	CHIP, METAL FILM, 1/20W 270 OHM J
R105	24000445	CHIP JUMPER, 1608TYPE
R106	24011682	CHIP, METAL FILM, 1/20W 6.8K OHM J

Location No.	Parts No.	Description
R107	24011122	CHIP, METAL FILM, 1/20W 1.2K OHM J
R108	24011471	CHIP, METAL FILM, 1/20W 470 OHM J
R109	24011102	CHIP, METAL FILM, 1/20W 1K OHM J
R110	24872360	CHIP, METAL FILM, 1/16W 36 OHM J
R112	24011562	CHIP, METAL FILM, 1/20W 5.6K OHM J
R113	24011102	CHIP, METAL FILM, 1/20W 1K OHM J
R114	24011471	CHIP, METAL FILM, 1/20W 470 OHM J
R115	24011472	CHIP, METAL FILM, 1/20W 4.7K OHM J
R116	24011681	CHIP, METAL FILM, 1/20W 680 OHM J
R117	24872360	CHIP, METAL FILM, 1/16W 36 OHM J
R118	24011103	CHIP, METAL FILM, 1/20W 10K OHM J
R119	24011472	CHIP, METAL FILM, 1/20W 4.7K OHM J
R121	24011103	CHIP, METAL FILM, 1/20W 10K OHM J
R122	24011221	CHIP, METAL FILM, 1/20W 220 OHM J
R123	24011101	CHIP, METAL FILM, 1/20W 100 OHM J
R124	24011331	CHIP, METAL FILM, 1/20W 330 OHM J
R125	24011101	CHIP, METAL FILM, 1/20W 100 OHM J
R126	24011101	CHIP, METAL FILM, 1/20W 100 OHM J
R127	24011102	CHIP, METAL FILM, 1/20W 1K OHM J
R128	24011102	CHIP, METAL FILM, 1/20W 1K OHM J
R129	24011272	CHIP, METAL FILM, 1/20W 2.7K OHM J
R130	24011101	CHIP, METAL FILM, 1/20W 100 OHM J
R131	24011221	CHIP, METAL FILM, 1/20W 220 OHM J
R132	24011684	CHIP, METAL FILM, 1/20W 680K OHM J
R135	24000445	CHIP JUMPER, 1608TYPE
R140	24011472	CHIP, METAL FILM, 1/20W 4.7K OHM J
R141	24011472	CHIP, METAL FILM, 1/20W 4.7K OHM J
R151	24011330	CHIP, METAL FILM, 1/20W 33 OHM J
R204	24011224	CHIP, METAL FILM, 1/20W 220K OHM J
R205	24011101	CHIP, METAL FILM, 1/20W 100 OHM J
R206	24366221	CARBON FILM, 1/6W 220 OHM J
R208	24011154	CHIP, METAL FILM, 1/20W 150K OHM J
R209	24011472	CHIP, METAL FILM, 1/20W 4.7K OHM J
R213	24872681	CHIP, METAL FILM, 1/16W 680 OHM J
R214	24872681	CHIP, METAL FILM, 1/16W 680 OHM J
R215	24872681	CHIP, METAL FILM, 1/16W 680 OHM J
R216	24872103	CHIP, METAL FILM, 1/16W 10K OHM J
R218	24011101	CHIP, METAL FILM, 1/20W 100 OHM J
R219	24011101	CHIP, METAL FILM, 1/20W 100 OHM J
R220	24011101	CHIP, METAL FILM, 1/20W 100 OHM J
R241	24367333	CARBON FILM, 1/6W 33K OHM G
R242	24367333	CARBON FILM, 1/6W 33K OHM G
R243	24367273	CARBON FILM, 1/6W 27K OHM G
R244	24366823	CARBON FILM, 1/6W 82K OHM J
R245	24366123	CARBON FILM, 1/6W 12K OHM J
R246	24366103	CARBON FILM, 1/6W 10K OHM J
R247	24366102	CARBON FILM, 1/6W 1K OHM J
R271	24011103	CHIP, METAL FILM, 1/20W 10K OHM J
R272	24011103	CHIP, METAL FILM, 1/20W 10K OHM J
R273	24011223	CHIP, METAL FILM, 1/20W 22K OHM J
R274	24011273	CHIP, METAL FILM, 1/20W 27K OHM J
R305	24323129	OXIDE METAL FILM, 2W 1.2 OHM J
R312	24366103	CARBON FILM, 1/6W 10K OHM J
R314	24366473	CARBON FILM, 1/6W 47K OHM J
R315	24366821	CARBON FILM, 1/6W 820 OHM J
R316	24011102	CHIP, METAL FILM, 1/20W 1K OHM J
R321	24011332	CHIP, METAL FILM, 1/20W 3.3K OHM J
R322	24000525	METAL FILM, 1/4W 4.7K OHM F
R323	24000525	METAL FILM, 1/4W 4.7K OHM F
R324	24366100	CARBON FILM, 1/6W 10 OHM J
R325	24011222	CHIP, METAL FILM, 1/20W 2.2K OHM J
R326	24366101	CARBON FILM, 1/6W 100 OHM J
R332	24000525	METAL FILM, 1/4W 4.7K OHM F
R333	24011470	CHIP, METAL FILM, 1/20W 47 OHM J
R334	24000525	METAL FILM, 1/4W 4.7K OHM F
R337	24321129	OXIDE METAL FILM, 1/2W 1.2 OHM J
R338	24366103	CARBON FILM, 1/6W 10K OHM J

Location No.	Parts No.	Description
R339	24366563	CARBON FILM, 1/6W 56K OHM J
R340	24366824	CARBON FILM, 1/6W 820K OHM J
R341	24366393	CARBON FILM, 1/6W 39K OHM J
R342	24366153	CARBON FILM, 1/6W 15K OHM J
R343	24366102	CARBON FILM, 1/6W 1K OHM J
R344	24382271	OXIDE METAL FILM, 1W 270 OHM J
R347	24366103	CARBON FILM, 1/6W 10K OHM J
R348	24366103	CARBON FILM, 1/6W 10K OHM J
R349	24366392	CARBON FILM, 1/6W 3.9K OHM J
R350	24366472	CARBON FILM, 1/6W 4.7K OHM J
R355	24011223	CHIP, METAL FILM, 1/20W 22K OHM J
R370	24011102	CHIP, METAL FILM, 1/20W 1K OHM J
R371	24011823	CHIP, METAL FILM, 1/20W 82K OHM J
R372	24011332	CHIP, METAL FILM, 1/20W 3.3K OHM J
R373	24011823	CHIP, METAL FILM, 1/20W 82K OHM J
R374	24011104	CHIP, METAL FILM, 1/20W 100K OHM J
R375	24011153	CHIP, METAL FILM, 1/20W 15K OHM J
R376	24011333	CHIP, METAL FILM, 1/20W 33K OHM J
R377	24000445	CHIP JUMPER, 1608TYPE
R378	24011332	CHIP, METAL FILM, 1/20W 3.3K OHM J
R390	24382561	OXIDE METAL FILM, 1W 560 OHM J
R391	24382561	OXIDE METAL FILM, 1W 560 OHM J
R392	24382561	OXIDE METAL FILM, 1W 560 OHM J
R401	24366222	CARBON FILM, 1/6W 2.2K OHM J
R402	24366102	CARBON FILM, 1/6W 1K OHM J
R403	24553272	OXIDE METAL FILM, 1W 2.7K OHM J
R404	24366332	CARBON FILM, 1/6W 3.3K OHM J
R405	24366101	CARBON FILM, 1/6W 100 OHM J
R406	24382472	OXIDE METAL FILM, 1W 4.7K OHM J
R407	24381100	OXIDE METAL FILM, 1/2W 10 OHM J
R408	24366222	CARBON FILM, 1/6W 2.2K OHM J
R409	24555220	OXIDE METAL FILM, 3W 22 OHM J
R410	24555220	OXIDE METAL FILM, 3W 22 OHM J
R411	24383270	OXIDE METAL FILM, 2W 27 OHM J
R412	24366222	CARBON FILM, 1/6W 2.2K OHM J
R413	24366332	CARBON FILM, 1/6W 3.3K OHM J
R414	24366100	CARBON FILM, 1/6W 10 OHM J
R415	24366102	CARBON FILM, 1/6W 1K OHM J
R416	24384682	OXIDE METAL FILM, 3W 6.8K OHM J
R417	24019292	FUSIBLE, 1/2W 68 OHM J
R418	24382104	OXIDE METAL FILM, 1W 100K OHM J
R419	24942102	CARBON COMPOSITION, 1/2W 1K OHM J
R420	24366103	CARBON FILM, 1/6W 10K OHM J
R421	24366223	CARBON FILM, 1/6W 22K OHM J
R422	24366223	CARBON FILM, 1/6W 22K OHM J
R431	24383102	OXIDE METAL FILM, 2W 1K OHM J
R432	24376274	CARBON FILM, 1/2W 270K OHM J
R433	24376274	CARBON FILM, 1/2W 270K OHM J
R434	24376274	CARBON FILM, 1/2W 270K OHM J
R435	24366562	CARBON FILM, 1/6W 5.6K OHM J
R441	24383102	OXIDE METAL FILM, 2W 1K OHM J
R442	24383102	OXIDE METAL FILM, 2W 1K OHM J
R443	24310109	OXIDE METAL FILM, 1/2W 1 OHM J
R444	24338398	OXIDE METAL FILM, 1W 0.39 OHM J
R445	24366103	CARBON FILM, 1/6W 10K OHM J
R446	24366103	CARBON FILM, 1/6W 10K OHM J
R447	24382473	OXIDE METAL FILM, 1W 47K OHM J
R448	24366334	CARBON FILM, 1/6W 330K OHM J
R449	24366821	CARBON FILM, 1/6W 820 OHM J
R460	24366103	CARBON FILM, 1/6W 10K OHM J
R461	24366103	CARBON FILM, 1/6W 10K OHM J
R462	24366103	CARBON FILM, 1/6W 10K OHM J
R463	24366562	CARBON FILM, 1/6W 5.6K OHM J
R464	24366472	CARBON FILM, 1/6W 4.7K OHM J
R465	24366474	CARBON FILM, 1/6W 470K OHM J
R466	24366103	CARBON FILM, 1/6W 10K OHM J
R467	24366683	CARBON FILM, 1/6W 68K OHM J

Location No.	Parts No.	Description
R469	24366101	CARBON FILM, 1/6W 100 OHM J
R470	24322568	OXIDE METAL FILM, 1W 0.56 OHM J
R470	24366224	CARBON FILM, 1/6W 220K OHM J
R471	24552271	OXIDE METAL FILM, 1/2W 270 OHM J
R472	24552151	OXIDE METAL FILM, 1/2W 150 OHM J
R473	24327223	METAL FILM, 1/4W 22K OHM F
R474	24327223	METAL FILM, 1/4W 22K OHM F
R475	24366102	CARBON FILM, 1/6W 1K OHM J
R475	24366103	CARBON FILM, 1/6W 10K OHM J
R476	24366223	CARBON FILM, 1/6W 22K OHM J
R477	24366332	CARBON FILM, 1/6W 3.3K OHM J
R478	24366474	CARBON FILM, 1/6W 470K OHM J
R479	24366103	CARBON FILM, 1/6W 10K OHM J
R480	24366223	CARBON FILM, 1/6W 22K OHM J
R481	24366472	CARBON FILM, 1/6W 4.7K OHM J
R482	24366681	CARBON FILM, 1/6W 680 OHM J
R483	24366103	CARBON FILM, 1/6W 10K OHM J
R484	24552821	OXIDE METAL FILM, 1/2W 820 OHM J
R488	24366392	CARBON FILM, 1/6W 3.9K OHM J
R489	24366222	CARBON FILM, 1/6W 2.2K OHM J
R490	24366103	CARBON FILM, 1/6W 10K OHM J
R491	24366102	CARBON FILM, 1/6W 1K OHM J
R492	24000370	METAL FILM, 1/4W 3.3K OHM F
R493	24000137	METAL FILM, 1/4W 150 OHM F
R494	24000364	METAL FILM, 1/4W 1.8K OHM F
R495	24366333	CARBON FILM, 1/6W 33K OHM J
R496	24366103	CARBON FILM, 1/6W 10K OHM J
R497	24366331	CARBON FILM, 1/6W 330 OHM J
R498	24366101	CARBON FILM, 1/6W 100 OHM J
R503	24366331	CARBON FILM, 1/6W 330 OHM J
R506	24011473	CHIP, METAL FILM, 1/20W 47K OHM J
R511	24011102	CHIP, METAL FILM, 1/20W 1K OHM J
R512	24011102	CHIP, METAL FILM, 1/20W 1K OHM J
R513	24366101	CARBON FILM, 1/6W 100 OHM J
R514	24011102	CHIP, METAL FILM, 1/20W 1K OHM J
R515	24011102	CHIP, METAL FILM, 1/20W 1K OHM J
R515	24366103	CARBON FILM, 1/6W 10K OHM J
R516	24011102	CHIP, METAL FILM, 1/20W 1K OHM J
R517	24011102	CHIP, METAL FILM, 1/20W 1K OHM J
R520	24011103	CHIP, METAL FILM, 1/20W 10K OHM J
R521	24011222	CHIP, METAL FILM, 1/20W 2.2K OHM J
R522	24011222	CHIP, METAL FILM, 1/20W 2.2K OHM J
R523	24011222	CHIP, METAL FILM, 1/20W 2.2K OHM J
R601	24011222	CHIP, METAL FILM, 1/20W 2.2K OHM J
R602	24011222	CHIP, METAL FILM, 1/20W 2.2K OHM J
R603	24011123	CHIP, METAL FILM, 1/20W 12K OHM J
R604	24011123	CHIP, METAL FILM, 1/20W 12K OHM J
R605	24011123	CHIP, METAL FILM, 1/20W 12K OHM J
R606	24011123	CHIP, METAL FILM, 1/20W 12K OHM J
R607	24011223	CHIP, METAL FILM, 1/20W 22K OHM J
R608	24011223	CHIP, METAL FILM, 1/20W 22K OHM J
R609	24366229	CARBON FILM, 1/6W 2.2 OHM J
R610	24366229	CARBON FILM, 1/6W 2.2 OHM J
R611	24011104	CHIP, METAL FILM, 1/20W 100K OHM J
R613	24011223	CHIP, METAL FILM, 1/20W 22K OHM J
R614	24011223	CHIP, METAL FILM, 1/20W 22K OHM J
R618	24011103	CHIP, METAL FILM, 1/20W 10K OHM J
R619	24011224	CHIP, METAL FILM, 1/20W 220K OHM J
R620	24552122	OXIDE METAL FILM, 1/2W 1.2K OHM J
R621	24011393	CHIP, METAL FILM, 1/20W 39K OHM J
R622	24011123	CHIP, METAL FILM, 1/20W 12K OHM J
R623	24011123	CHIP, METAL FILM, 1/20W 12K OHM J
R636	24872822	CHIP, METAL FILM, 1/16W 8.2K OHM J
R637	24872822	CHIP, METAL FILM, 1/16W 8.2K OHM J
R646	24872822	CHIP, METAL FILM, 1/16W 8.2K OHM J
R647	24872822	CHIP, METAL FILM, 1/16W 8.2K OHM J
R688	24552391	OXIDE METAL FILM, 1/2W 390 OHM J

Location No.	Parts No.	Description
R690	24552391	OXIDE METAL FILM, 1/2W 390 OHM J
R699	24011101	CHIP, METAL FILM, 1/20W 100 OHM J
R701	24011221	CHIP, METAL FILM, 1/20W 220 OHM J
R702	24011221	CHIP, METAL FILM, 1/20W 220 OHM J
R703	24011472	CHIP, METAL FILM, 1/20W 4.7K OHM J
R704	24011472	CHIP, METAL FILM, 1/20W 4.7K OHM J
R711	24011100	CHIP, METAL FILM, 1/20W 10 OHM J
R712	24011100	CHIP, METAL FILM, 1/20W 10 OHM J
R713	24011100	CHIP, METAL FILM, 1/20W 10 OHM J
R714	24011100	CHIP, METAL FILM, 1/20W 10 OHM J
R718	24011221	CHIP, METAL FILM, 1/20W 220 OHM J
R720	24011103	CHIP, METAL FILM, 1/20W 10K OHM J
R721	24011103	CHIP, METAL FILM, 1/20W 10K OHM J
R722	24011561	CHIP, METAL FILM, 1/20W 560 OHM J
R723	24011102	CHIP, METAL FILM, 1/20W 1K OHM J
R724	24011102	CHIP, METAL FILM, 1/20W 1K OHM J
R725	24011102	CHIP, METAL FILM, 1/20W 1K OHM J
R727	24011222	CHIP, METAL FILM, 1/20W 2.2K OHM J
R728	24011221	CHIP, METAL FILM, 1/20W 220 OHM J
R729	24011221	CHIP, METAL FILM, 1/20W 220 OHM J
R732	24011473	CHIP, METAL FILM, 1/20W 47K OHM J
R733	24011473	CHIP, METAL FILM, 1/20W 47K OHM J
R734	24011221	CHIP, METAL FILM, 1/20W 220 OHM J
R735	24011911	CHIP, METAL FILM, 1/20W 910 OHM J
R736	24011911	CHIP, METAL FILM, 1/20W 910 OHM J
R737	24998102	CHIP, 1/16W 1K OHM
R738	24998392	CHIP, 1/16W 3.9K OHM
R739	24998562	CHIP, METAL FILM, 1/16W 5.6K OHM
R740	24011911	CHIP, METAL FILM, 1/20W 910 OHM J
R741	24011911	CHIP, METAL FILM, 1/20W 910 OHM J
R742	24998102	CHIP, 1/16W 1K OHM
R743	24998392	CHIP, 1/16W 3.9K OHM
R744	24998562	CHIP, METAL FILM, 1/16W 5.6K OHM
R745	24011911	CHIP, METAL FILM, 1/20W 910 OHM J
R746	24011911	CHIP, METAL FILM, 1/20W 910 OHM J
R747	24998102	CHIP, 1/16W 1K OHM
R748	24998392	CHIP, 1/16W 3.9K OHM
R749	24998562	CHIP, METAL FILM, 1/16W 5.6K OHM
R750	24011911	CHIP, METAL FILM, 1/20W 910 OHM J
R751	24011911	CHIP, METAL FILM, 1/20W 910 OHM J
R752	24998102	CHIP, 1/16W 1K OHM
R753	24998392	CHIP, 1/16W 3.9K OHM
R754	24998562	CHIP, METAL FILM, 1/16W 5.6K OHM
R755	24011911	CHIP, METAL FILM, 1/20W 910 OHM J
R756	24011911	CHIP, METAL FILM, 1/20W 910 OHM J
R757	24998102	CHIP, 1/16W 1K OHM
R758	24998392	CHIP, 1/16W 3.9K OHM
R759	24998562	CHIP, METAL FILM, 1/16W 5.6K OHM
R760	24011911	CHIP, METAL FILM, 1/20W 910 OHM J
R761	24011911	CHIP, METAL FILM, 1/20W 910 OHM J
R762	24998102	CHIP, 1/16W 1K OHM
R763	24998392	CHIP, 1/16W 3.9K OHM
R764	24998562	CHIP, METAL FILM, 1/16W 5.6K OHM
R786	24011472	CHIP, METAL FILM, 1/20W 4.7K OHM J
R787	24011472	CHIP, METAL FILM, 1/20W 4.7K OHM J
R790	24011101	CHIP, METAL FILM, 1/20W 100 OHM J
R796	24011101	CHIP, METAL FILM, 1/20W 100 OHM J
△ R801	24005015	METAL GLAZE, 1W 8.2M OHM J
R810	24510152	CERAMIC COVERED, 5W 1.5K OHM J
R819	24009954	METAL FILM, 1/2W 2.2M OHM J
R820	24327153	METAL FILM, 1/4W 15K OHM J
R821	24327123	METAL FILM, 1/4W 12K OHM F
R822	24327123	METAL FILM, 1/4W 12K OHM F
R823	24327123	METAL FILM, 1/4W 12K OHM F
R824	24366122	CARBON FILM, 1/6W 1.2K OHM J
R825	24510150	CERAMIC COVERED, 5W 15 OHM J
R830	24366472	CARBON FILM, 1/6W 4.7K OHM J

Location No.	Parts No.	Description
R831	24366334	CARBON FILM, 1/6W 330K OHM J
R832	24366471	CARBON FILM, 1/6W 470 OHM J
R833	24366681	CARBON FILM, 1/6W 680 OHM J
R834	24366102	CARBON FILM, 1/6W 1K OHM J
R835	24366102	CARBON FILM, 1/6W 1K OHM J
R836	24366102	CARBON FILM, 1/6W 1K OHM J
R841	24321189	OXIDE METAL FILM, 1/2W 1.8 OHM J
R842	24321229	OXIDE METAL FILM, 1/2W 2.2 OHM J
R861	24555333	OXIDE METAL FILM, 3W 33K OHM J
R862	24321689	OXIDE METAL FILM, 1/2W 6.8 OHM J
R864	24552102	OXIDE METAL FILM, 1/2W 1K OHM J
R865	24545109	FUSIBLE, 1/4W 1 OHM J
R866	24552470	OXIDE METAL FILM, 1/2W 47 OHM J
R867	24367563	CARBON FILM, 1/6W 56K OHM G
R868	24552560	OXIDE METAL FILM, 1/2W 56 OHM J
R870	24552121	OXIDE METAL FILM, 1/2W 120 OHM J
R871	24553680	OXIDE METAL FILM, 1W 68 OHM J
R872	24377224	CARBON FILM, 1W 220K OHM J
R883	24381683	OXIDE METAL FILM, 1/2W 68K OHM J
R884	24366102	CARBON FILM, 1/6W 1K OHM J
R891	24366152	CARBON FILM, 1/6W 1.5K OHM J
R900	24000921	FUSIBLE, 2W 1.2 OHM J
R901	24366101	CARBON FILM, 1/6W 100 OHM J
R903	24942102	CARBON COMPOSITION, 1/2W 1K OHM J
R905	24366390	CARBON FILM, 1/6W 39 OHM J
R906	24366561	CARBON FILM, 1/6W 560 OHM J
R908	24366560	CARBON FILM, 1/6W 56 OHM J
R909	24366121	CARBON FILM, 1/6W 120 OHM J
R911	24366101	CARBON FILM, 1/6W 100 OHM J
R913	24942102	CARBON COMPOSITION, 1/2W 1K OHM J
R915	24366330	CARBON FILM, 1/6W 33 OHM J
R916	24366561	CARBON FILM, 1/6W 560 OHM J
R918	24366430	CARBON FILM, 1/6W 43 OHM J
R921	24366101	CARBON FILM, 1/6W 100 OHM J
R923	24942102	CARBON COMPOSITION, 1/2W 1K OHM J
R925	24366121	CARBON FILM, 1/6W 120 OHM J
R926	24366561	CARBON FILM, 1/6W 560 OHM J
R928	24366680	CARBON FILM, 1/6W 68 OHM J
R931	24555153	OXIDE METAL FILM, 3W 15K OHM J
R932	24555153	OXIDE METAL FILM, 3W 15K OHM J
R935	24366150	CARBON FILM, 1/6W 15 OHM J
R941	24555153	OXIDE METAL FILM, 3W 15K OHM J
R942	24555153	OXIDE METAL FILM, 3W 15K OHM J
R949	24366101	CARBON FILM, 1/6W 100 OHM J
R951	24555153	OXIDE METAL FILM, 3W 15K OHM J
R952	24555153	OXIDE METAL FILM, 3W 15K OHM J
R953	24366390	CARBON FILM, 1/6W 39 OHM J
R956	24366102	CARBON FILM, 1/6W 1K OHM J
R961	24366102	CARBON FILM, 1/6W 1K OHM J
R962	24366301	CARBON FILM, 1/6W 300 OHM J
R964	24366332	CARBON FILM, 1/6W 3.3K OHM J
R965	24366471	CARBON FILM, 1/6W 470 OHM J
R966	24366821	CARBON FILM, 1/6W 820 OHM J
R967	24366102	CARBON FILM, 1/6W 1K OHM J
R968	24366680	CARBON FILM, 1/6W 68 OHM J
R969	24366103	CARBON FILM, 1/6W 10K OHM J
R970	24366222	CARBON FILM, 1/6W 2.2K OHM J
R971	24367152	CARBON FILM, 1/6W 1.5K OHM G
R972	24367471	CARBON FILM, 1/6W 470 OHM G
R973	24367681	CARBON FILM, 1/6W 680 OHM G
R974	24367681	CARBON FILM, 1/6W 680 OHM G
R975	24366242	CARBON FILM, 1/6W 2.4K OHM J
R976	24367562	CARBON FILM, 1/6W 5.6K OHM G
R977	24367472	CARBON FILM, 1/6W 4.7K OHM G
R978	24367681	CARBON FILM, 1/6W 680 OHM G
R4403	24011682	CHIP, METAL FILM, 1/20W 6.8K OHM J
R4404	24011101	CHIP, METAL FILM, 1/20W 100 OHM J



Location No.	Parts No.	Description
R4406	24011333	CHIP, METAL FILM, 1/20W 33K OHM J
R4407	24011223	CHIP, METAL FILM, 1/20W 22K OHM J
R4408	24011102	CHIP, METAL FILM, 1/20W 1K OHM J
R4409	24011471	CHIP, METAL FILM, 1/20W 470 OHM J
R4411	24011103	CHIP, METAL FILM, 1/20W 10K OHM J
R4412	24011222	CHIP, METAL FILM, 1/20W 2.2K OHM J
R4415	24011103	CHIP, METAL FILM, 1/20W 10K OHM J
R4416	24011152	CHIP, METAL FILM, 1/20W 1.5K OHM J
R4417	24011682	CHIP, METAL FILM, 1/20W 6.8K OHM J
R4419	24011470	CHIP, METAL FILM, 1/20W 47 OHM J
R4420	24011222	CHIP, METAL FILM, 1/20W 2.2K OHM J
R4421	24011271	CHIP, METAL FILM, 1/20W 270 OHM J
R4422	24011223	CHIP, METAL FILM, 1/20W 22K OHM J
R4423	24011223	CHIP, METAL FILM, 1/20W 22K OHM J
R4424	24011223	CHIP, METAL FILM, 1/20W 22K OHM J
R4425	24011223	CHIP, METAL FILM, 1/20W 22K OHM J
R4426	24011223	CHIP, METAL FILM, 1/20W 22K OHM J
R4427	24011103	CHIP, METAL FILM, 1/20W 10K OHM J
R4428	24011101	CHIP, METAL FILM, 1/20W 100 OHM J
R4429	24011102	CHIP, METAL FILM, 1/20W 1K OHM J
R4451	24011472	CHIP, METAL FILM, 1/20W 4.7K OHM J
R4452	24011103	CHIP, METAL FILM, 1/20W 10K OHM J
R4453	24011272	CHIP, METAL FILM, 1/20W 2.7K OHM J
R4454	24011102	CHIP, METAL FILM, 1/20W 1K OHM J
R4471	24366681	CARBON FILM, 1/6W 680 OHM J
R7166	24011223	CHIP, METAL FILM, 1/20W 22K OHM J
R7167	24011153	CHIP, METAL FILM, 1/20W 15K OHM J
R7173	24011224	CHIP, METAL FILM, 1/20W 220K OHM J
R7179	24011102	CHIP, METAL FILM, 1/20W 1K OHM J
R7180	24011102	CHIP, METAL FILM, 1/20W 1K OHM J
R7181	24011333	CHIP, METAL FILM, 1/20W 33K OHM J
R7195	24011100	CHIP, METAL FILM, 1/20W 10 OHM J
R7196	24011100	CHIP, METAL FILM, 1/20W 10 OHM J
R7197	24011100	CHIP, METAL FILM, 1/20W 10 OHM J
R7198	24011221	CHIP, METAL FILM, 1/20W 220 OHM J
R7316	24011102	CHIP, METAL FILM, 1/20W 1K OHM J
R7707	24366472	CARBON FILM, 1/6W 4.7K OHM J
R7708	24366472	CARBON FILM, 1/6W 4.7K OHM J
R7709	24366102	CARBON FILM, 1/6W 1K OHM J
R7710	24383680	OXIDE METAL FILM, 2W 68 OHM J
R7711	24547189	FUSIBLE, 1W 1.8 OHM J
R7712	24366472	CARBON FILM, 1/6W 4.7K OHM J
R7713	24366472	CARBON FILM, 1/6W 4.7K OHM J
R7714	24366102	CARBON FILM, 1/6W 1K OHM J
R7715	24383680	OXIDE METAL FILM, 2W 68 OHM J
R7716	24547189	FUSIBLE, 1W 1.8 OHM J
R7717	24366472	CARBON FILM, 1/6W 4.7K OHM J
R7718	24366472	CARBON FILM, 1/6W 4.7K OHM J
R7719	24366102	CARBON FILM, 1/6W 1K OHM J
R7720	24383680	OXIDE METAL FILM, 2W 68 OHM J
R7721	24547189	FUSIBLE, 1W 1.8 OHM J
R7722	24366472	CARBON FILM, 1/6W 4.7K OHM J
R7723	24366472	CARBON FILM, 1/6W 4.7K OHM J
R7724	24366102	CARBON FILM, 1/6W 1K OHM J
R7725	24383680	OXIDE METAL FILM, 2W 68 OHM J
R7726	24547189	FUSIBLE, 1W 1.8 OHM J
R7727	24366472	CARBON FILM, 1/6W 4.7K OHM J
R7728	24366472	CARBON FILM, 1/6W 4.7K OHM J
R7729	24366102	CARBON FILM, 1/6W 1K OHM J
R7730	24383680	OXIDE METAL FILM, 2W 68 OHM J
R7731	24547189	FUSIBLE, 1W 1.8 OHM J
R7732	24366472	CARBON FILM, 1/6W 4.7K OHM J
R7733	24366472	CARBON FILM, 1/6W 4.7K OHM J
R7734	24366102	CARBON FILM, 1/6W 1K OHM J
R7735	24383680	OXIDE METAL FILM, 2W 68 OHM J
R7736	24547189	FUSIBLE, 1W 1.8 OHM J
R7777	24366103	CARBON FILM, 1/6W 10K OHM J

Location No.	Parts No.	Description
R7799	24366222	CARBON FILM, 1/6W 2.2K OHM J
R7845	24366221	CARBON FILM, 1/6W 220 OHM J
R7846	24366472	CARBON FILM, 1/6W 4.7K OHM J
R7847	24366103	CARBON FILM, 1/6W 10K OHM J
R7848	24366103	CARBON FILM, 1/6W 10K OHM J
R7849	24366103	CARBON FILM, 1/6W 10K OHM J
R7850	24366224	CARBON FILM, 1/6W 220K OHM J
R7851	24366153	CARBON FILM, 1/6W 15K OHM J
R7852	24366103	CARBON FILM, 1/6W 10K OHM J
R7853	24366154	CARBON FILM, 1/6W 150K OHM J
R7854	24366154	CARBON FILM, 1/6W 150K OHM J
R7863	24366222	CARBON FILM, 1/6W 2.2K OHM J
R7864	24366222	CARBON FILM, 1/6W 2.2K OHM J
R7866	24366154	CARBON FILM, 1/6W 150K OHM J
R7867	24366154	CARBON FILM, 1/6W 150K OHM J
R7890	24366222	CARBON FILM, 1/6W 2.2K OHM J
R7891	24366222	CARBON FILM, 1/6W 2.2K OHM J
R7895	24366222	CARBON FILM, 1/6W 2.2K OHM J
R9601	24366471	CARBON FILM, 1/6W 470 OHM J
R9602	24366392	CARBON FILM, 1/6W 3.9K OHM J
R9603	24366392	CARBON FILM, 1/6W 3.9K OHM J
R9604	24366272	CARBON FILM, 1/6W 2.7K OHM J
R9605	24366682	CARBON FILM, 1/6W 6.8K OHM J
R9606	24366332	CARBON FILM, 1/6W 3.3K OHM J
R9613	24366680	CARBON FILM, 1/6W 68 OHM J
R9614	24366390	CARBON FILM, 1/6W 39 OHM J
R9615	24366101	CARBON FILM, 1/6W 100 OHM J
R9616	24366102	CARBON FILM, 1/6W 1K OHM J
RA02	24011102	CHIP, METAL FILM, 1/20W 1K OHM J
RA03	24011102	CHIP, METAL FILM, 1/20W 1K OHM J
RA04	24011102	CHIP, METAL FILM, 1/20W 1K OHM J
RA05	24011103	CHIP, METAL FILM, 1/20W 10K OHM J
RA06	24011102	CHIP, METAL FILM, 1/20W 1K OHM J
RA07	24011103	CHIP, METAL FILM, 1/20W 10K OHM J
RA08	24011472	CHIP, METAL FILM, 1/20W 4.7K OHM J
RA09	24011103	CHIP, METAL FILM, 1/20W 10K OHM J
RA10	24011103	CHIP, METAL FILM, 1/20W 10K OHM J
RA11	24011103	CHIP, METAL FILM, 1/20W 10K OHM J
RA12	24011102	CHIP, METAL FILM, 1/20W 1K OHM J
RA13	24011102	CHIP, METAL FILM, 1/20W 1K OHM J
RA14	24011331	CHIP, METAL FILM, 1/20W 330 OHM J
RA15	24011472	CHIP, METAL FILM, 1/20W 4.7K OHM J
RA16	24011331	CHIP, METAL FILM, 1/20W 330 OHM J
RA17	24011102	CHIP, METAL FILM, 1/20W 1K OHM J
RA18	24000594	CHIP, 1/16W 12K OHM F
RA20	24000594	CHIP, 1/16W 12K OHM F
RA21	24011102	CHIP, METAL FILM, 1/20W 1K OHM J
RA22	24011224	CHIP, METAL FILM, 1/20W 220K OHM J
RA23	24011332	CHIP, METAL FILM, 1/20W 3.3K OHM J
RA24	24011332	CHIP, METAL FILM, 1/20W 3.3K OHM J
RA25	24011332	CHIP, METAL FILM, 1/20W 3.3K OHM J
RA26	24011103	CHIP, METAL FILM, 1/20W 10K OHM J
RA27	24011102	CHIP, METAL FILM, 1/20W 1K OHM J
RA28	24011102	CHIP, METAL FILM, 1/20W 1K OHM J
RA29	24011333	CHIP, METAL FILM, 1/20W 33K OHM J
RA30	24011103	CHIP, METAL FILM, 1/20W 10K OHM J
RA31	24011102	CHIP, METAL FILM, 1/20W 1K OHM J
RA32	24011101	CHIP, METAL FILM, 1/20W 100 OHM J
RA33	24011102	CHIP, METAL FILM, 1/20W 1K OHM J
RA34	24011101	CHIP, METAL FILM, 1/20W 100 OHM J
RA35	24011333	CHIP, METAL FILM, 1/20W 33K OHM J
RA36	24011472	CHIP, METAL FILM, 1/20W 4.7K OHM J
RA37	24011102	CHIP, METAL FILM, 1/20W 1K OHM J
RA38	24011472	CHIP, METAL FILM, 1/20W 4.7K OHM J
RA39	24011102	CHIP, METAL FILM, 1/20W 1K OHM J
RA40	24011222	CHIP, METAL FILM, 1/20W 2.2K OHM J
RA41	24011103	CHIP, METAL FILM, 1/20W 10K OHM J

Location No.	Parts No.	Description
RA42	24011101	CHIP, METAL FILM, 1/20W 100 OHM J
RA43	24011222	CHIP, METAL FILM, 1/20W 2.2K OHM J
RA44	24011222	CHIP, METAL FILM, 1/20W 2.2K OHM J
RA45	24011222	CHIP, METAL FILM, 1/20W 2.2K OHM J
RA46	24011222	CHIP, METAL FILM, 1/20W 2.2K OHM J
RA47	24011101	CHIP, METAL FILM, 1/20W 100 OHM J
RA48	24011101	CHIP, METAL FILM, 1/20W 100 OHM J
RA49	24011222	CHIP, METAL FILM, 1/20W 2.2K OHM J
RA50	24011102	CHIP, METAL FILM, 1/20W 1K OHM J
RA61	24011103	CHIP, METAL FILM, 1/20W 10K OHM J
RA62	24011103	CHIP, METAL FILM, 1/20W 10K OHM J
RA63	24011472	CHIP, METAL FILM, 1/20W 4.7K OHM J
RA71	24366113	CARBON FILM, 1/6W 11K OHM J
RA72	24366512	CARBON FILM, 1/6W 5.1K OHM J
RA73	24366272	CARBON FILM, 1/6W 2.7K OHM J
RA84	24011223	CHIP, METAL FILM, 1/20W 22K OHM J
RA85	24011103	CHIP, METAL FILM, 1/20W 10K OHM J
RA86	24011332	CHIP, METAL FILM, 1/20W 3.3K OHM J
RA87	24011332	CHIP, METAL FILM, 1/20W 3.3K OHM J
RB01	24011182	CHIP, METAL FILM, 1/20W 1.8K OHM J
RB01	24366471	CARBON FILM, 1/6W 470 OHM J
RB02	24011474	CHIP, METAL FILM, 1/20W 470K OHM J
RB03	24011333	CHIP, METAL FILM, 1/20W 33K OHM J
RB04	24011123	CHIP, METAL FILM, 1/20W 12K OHM J
RB05	24011392	CHIP, METAL FILM, 1/20W 3.9K OHM J
RB06	24011392	CHIP, METAL FILM, 1/20W 3.9K OHM J
RB07	24011223	CHIP, METAL FILM, 1/20W 22K OHM J
RB08	24366471	CARBON FILM, 1/6W 470 OHM J
RB09	24011103	CHIP, METAL FILM, 1/20W 10K OHM J
RB09	24366470	CARBON FILM, 1/6W 47 OHM J
RB10	24011152	CHIP, METAL FILM, 1/20W 1.5K OHM J
RB10	24366101	CARBON FILM, 1/6W 100 OHM J
RB11	24011103	CHIP, METAL FILM, 1/20W 10K OHM J
RB11	24366103	CARBON FILM, 1/6W 10K OHM J
RB12	24366471	CARBON FILM, 1/6W 470 OHM J
RB96	24011472	CHIP, METAL FILM, 1/20W 4.7K OHM J
RB97	24011472	CHIP, METAL FILM, 1/20W 4.7K OHM J
RC01	24011681	CHIP, METAL FILM, 1/20W 680 OHM J
RC02	24011681	CHIP, METAL FILM, 1/20W 680 OHM J
RC03	24011681	CHIP, METAL FILM, 1/20W 680 OHM J
RC04	24011681	CHIP, METAL FILM, 1/20W 680 OHM J
RC05	24011681	CHIP, METAL FILM, 1/20W 680 OHM J
RC06	24011681	CHIP, METAL FILM, 1/20W 680 OHM J
RC60	24366681	CARBON FILM, 1/6W 680 OHM J
RC61	24366681	CARBON FILM, 1/6W 680 OHM J
RR01	24011103	CHIP, METAL FILM, 1/20W 10K OHM J
RR03	24011682	CHIP, METAL FILM, 1/20W 6.8K OHM J
RR06	24011332	CHIP, METAL FILM, 1/20W 3.3K OHM J
RR13	24011151	CHIP, METAL FILM, 1/20W 150 OHM J
RR14	24011151	CHIP, METAL FILM, 1/20W 150 OHM J
RR15	24011151	CHIP, METAL FILM, 1/20W 150 OHM J
RR62	24011100	CHIP, METAL FILM, 1/20W 10 OHM J
RR63	24011362	CHIP, METAL FILM, 1/20W 3.6K OHM J
RR64	24011751	CHIP, METAL FILM, 1/20W 750 OHM J
RR65	24011102	CHIP, METAL FILM, 1/20W 1K OHM J
RR66	24011510	CHIP, METAL FILM, 1/20W 51 OHM J
RR67	24011100	CHIP, METAL FILM, 1/20W 10 OHM J
RR68	24011362	CHIP, METAL FILM, 1/20W 3.6K OHM J
RR69	24011751	CHIP, METAL FILM, 1/20W 750 OHM J
RR70	24011102	CHIP, METAL FILM, 1/20W 1K OHM J
RR71	24011510	CHIP, METAL FILM, 1/20W 51 OHM J
RR84	24011100	CHIP, METAL FILM, 1/20W 10 OHM J
RR85	24011102	CHIP, METAL FILM, 1/20W 1K OHM J
RR86	24011751	CHIP, METAL FILM, 1/20W 750 OHM J
RR87	24011362	CHIP, METAL FILM, 1/20W 3.6K OHM J
RR88	24011510	CHIP, METAL FILM, 1/20W 51 OHM J
RS01	24011271	CHIP, METAL FILM, 1/20W 270 OHM J

Location No.	Parts No.	Description
RS02	24011271	CHIP, METAL FILM, 1/20W 270 OHM J
RS03	24011562	CHIP, METAL FILM, 1/20W 5.6K OHM J
RS04	24011562	CHIP, METAL FILM, 1/20W 5.6K OHM J
RS05	24011562	CHIP, METAL FILM, 1/20W 5.6K OHM J
RS06	24011562	CHIP, METAL FILM, 1/20W 5.6K OHM J
RS07	24011562	CHIP, METAL FILM, 1/20W 5.6K OHM J
RS08	24011562	CHIP, METAL FILM, 1/20W 5.6K OHM J
RS09	24011562	CHIP, METAL FILM, 1/20W 5.6K OHM J
RS10	24011562	CHIP, METAL FILM, 1/20W 5.6K OHM J
RS13	24011101	CHIP, METAL FILM, 1/20W 100 OHM J
RS14	24011101	CHIP, METAL FILM, 1/20W 100 OHM J
RS15	24011104	CHIP, METAL FILM, 1/20W 100K OHM J
RS16	24011104	CHIP, METAL FILM, 1/20W 100K OHM J
RS17	24011223	CHIP, METAL FILM, 1/20W 22K OHM J
RS18	24011223	CHIP, METAL FILM, 1/20W 22K OHM J
RS23	24011223	CHIP, METAL FILM, 1/20W 22K OHM J
RS24	24011223	CHIP, METAL FILM, 1/20W 22K OHM J
RS25	24011223	CHIP, METAL FILM, 1/20W 22K OHM J
RS26	24011223	CHIP, METAL FILM, 1/20W 22K OHM J
RS49	24011271	CHIP, METAL FILM, 1/20W 270 OHM J
RS50	24011271	CHIP, METAL FILM, 1/20W 270 OHM J
RS51	24011104	CHIP, METAL FILM, 1/20W 100K OHM J
RS52	24011104	CHIP, METAL FILM, 1/20W 100K OHM J
RS53	24011223	CHIP, METAL FILM, 1/20W 22K OHM J
RS54	24011223	CHIP, METAL FILM, 1/20W 22K OHM J
RS55	24011103	CHIP, METAL FILM, 1/20W 10K OHM J
RS56	24011104	CHIP, METAL FILM, 1/20W 100K OHM J
RV07	24011103	CHIP, METAL FILM, 1/20W 10K OHM J
RV08	24011103	CHIP, METAL FILM, 1/20W 10K OHM J
RV09	24011101	CHIP, METAL FILM, 1/20W 100 OHM J
RV10	24011101	CHIP, METAL FILM, 1/20W 100 OHM J
RV23	24552101	OXIDE METAL FILM, 1/2W 100 OHM J
RV25	24011101	CHIP, METAL FILM, 1/20W 100 OHM J
RV26	24011471	CHIP, METAL FILM, 1/20W 470 OHM J
RV27	24872750	CHIP, METAL FILM, 1/16W 75 OHM J
RV28	24011562	CHIP, METAL FILM, 1/20W 5.6K OHM J
RV29	24011103	CHIP, METAL FILM, 1/20W 10K OHM J
RV30	24872750	CHIP, METAL FILM, 1/16W 75 OHM J
RV32	24872750	CHIP, METAL FILM, 1/16W 75 OHM J
RV33	24011562	CHIP, METAL FILM, 1/20W 5.6K OHM J
RV34	24011562	CHIP, METAL FILM, 1/20W 5.6K OHM J
RV37	24872750	CHIP, METAL FILM, 1/16W 75 OHM J
RV38	24872750	CHIP, METAL FILM, 1/16W 75 OHM J
RV43	24011222	CHIP, METAL FILM, 1/20W 2.2K OHM J
RV61	24552101	OXIDE METAL FILM, 1/2W 100 OHM J
RV62	24011101	CHIP, METAL FILM, 1/20W 100 OHM J
RV63	24011471	CHIP, METAL FILM, 1/20W 470 OHM J
RV64	24872750	CHIP, METAL FILM, 1/16W 75 OHM J
RV65	24552101	OXIDE METAL FILM, 1/2W 100 OHM J
RV66	24872750	CHIP, METAL FILM, 1/16W 75 OHM J
RV67	24011471	CHIP, METAL FILM, 1/20W 470 OHM J
RV68	24011101	CHIP, METAL FILM, 1/20W 100 OHM J
RV81	24872750	CHIP, METAL FILM, 1/16W 75 OHM J
RV85	24872750	CHIP, METAL FILM, 1/16W 75 OHM J
RV86	24872750	CHIP, METAL FILM, 1/16W 75 OHM J
RV87	24872750	CHIP, METAL FILM, 1/16W 75 OHM J
RV88	24872151	CHIP, METAL FILM, 1/16W 150 OHM J
RV89	24872151	CHIP, METAL FILM, 1/16W 150 OHM J
RW02	24366271	CARBON FILM, 1/6W 270 OHM J
RW09	24366563	CARBON FILM, 1/6W 56K OHM J
RW13	24366393	CARBON FILM, 1/6W 39K OHM J
RW14	24552121	OXIDE METAL FILM, 1/2W 120 OHM J
RW15	24366473	CARBON FILM, 1/6W 47K OHM J
RW16	24366273	CARBON FILM, 1/6W 27K OHM J
RW17	24366333	CARBON FILM, 1/6W 33K OHM J
RW18	24366101	CARBON FILM, 1/6W 100 OHM J
RW19	24366100	CARBON FILM, 1/6W 10 OHM J

Location No.	Parts No.	Description
RW20	24366392	CARBON FILM, 1/6W 3.9K OHM J
RW22	24366102	CARBON FILM, 1/6W 1K OHM J
RW23	24366101	CARBON FILM, 1/6W 100 OHM J
RW24	24366331	CARBON FILM, 1/6W 330 OHM J
RW25	24366182	CARBON FILM, 1/6W 1.8K OHM J
RW30	24552100	OXIDE METAL FILM, 1/2W 10 OHM J
RW31	24552331	OXIDE METAL FILM, 1/2W 330 OHM J
RW32	24366820	CARBON FILM, 1/6W 82 OHM J
RW33	24366683	CARBON FILM, 1/6W 68K OHM J
RW34	24366820	CARBON FILM, 1/6W 82 OHM J
RW35	24366683	CARBON FILM, 1/6W 68K OHM J
RW36	24366330	CARBON FILM, 1/6W 33 OHM J
RW37	24366152	CARBON FILM, 1/6W 1.5K OHM J
RW38	24366102	CARBON FILM, 1/6W 1K OHM J
RW39	24366152	CARBON FILM, 1/6W 1.5K OHM J
RW40	24366330	CARBON FILM, 1/6W 33 OHM J
RW41	24366279	CARBON FILM, 1/6W 2.7 OHM J
RW42	24366279	CARBON FILM, 1/6W 2.7 OHM J
RW43	24554221	OXIDE METAL FILM, 2W 220 OHM J
RW44	24366122	CARBON FILM, 1/6W 1.2K OHM J
RW45	24366122	CARBON FILM, 1/6W 1.2K OHM J
<b>COILS &amp; TRANSFORMERS</b>		
L101	23238562	COIL, PEAKING, TRF4109AJ
L102	23238561	COIL, PEAKING-0.82MMHK, COLTRF4R82AJ
L103	23238554	COIL, PEAKING, TRF4R22AJ
L104	23248035	COIL, CHOKE, TLN3278D
L106	23289846	COIL, PEAKING, TRF4101AT
L110	23238711	COIL, PEAKING, TRF4180AJ
L111	23238715	COIL, PEAKING, TRF4829AJ
L112	23289100	COIL, PEAKING, TRF4100AF
L113	23289100	COIL, PEAKING, TRF4100AF
L302	23248073	COIL, CHOKE, TLN3299D
L303	23248073	COIL, CHOKE, TLN3299D
L304	23103859	FILTER, FERRITE CHOKE, TEM2011
L310	23237975	COIL, PEAKING, TRF4101AC
L401	23289560	COIL, PEAKING, TRF4560AF
L402	23248244	COIL, CHOKE, TLN3497AH
L404	23248242	COIL, CHOKE, TLN3495AH
L405	23221076	COIL, HORIZ/RF CHOKE, TLN1015R
L406	23248243	COIL, CHOKE, TLN3496AH
L407	23103775	COIL, FERRITE CHOKE, TEM2014
L408	23103775	COIL, FERRITE CHOKE, TEM2014
L409	23237975	COIL, PEAKING, TRF4101AC
L441	23233977	COIL, TLN2203AG
L442	23248196	COIL, CHOKE, TLN3457AD
L462	23231359	DEFLECTION YOKE, MIX YOKE, TDY707JTA
L463	23231359	DEFLECTION YOKE, MIX YOKE, TDY707JTA
L464	23231359	DEFLECTION YOKE, MIX YOKE, TDY707JTA
L472	23102441	MAGNET, CONVERGENCE, MAG1094
L473	23102441	MAGNET, CONVERGENCE, MAG1094
L474	23102441	MAGNET, CONVERGENCE, MAG1094
L502	23289844	COIL, PEAKING, TRF4470AT
L701	23103828	INDUCTOR, BEAD, TEM2121M
L702	23103828	INDUCTOR, BEAD, TEM2121M
L711	23238562	COIL, PEAKING, TRF4109AJ
L712	23238562	COIL, PEAKING, TRF4109AJ
L713	23238562	COIL, PEAKING, TRF4109AJ
L714	23238562	COIL, PEAKING, TRF4109AJ
L720	23289102	COIL, PEAKING, TRF4102AF
L721	23237805	COIL, PEAKING, TRF4222AC
L722	23289102	COIL, PEAKING, TRF4102AF
L723	23237805	COIL, PEAKING, TRF4222AC
L724	23289102	COIL, PEAKING, TRF4102AF
L725	23237805	COIL, PEAKING, TRF4222AC
L726	23289102	COIL, PEAKING, TRF4102AF
L727	23237805	COIL, PEAKING, TRF4222AC

Location No.	Parts No.	Description
L728	23289102	COIL, PEAKING, TRF4102AF
L729	23237805	COIL, PEAKING, TRF4222AC
L730	23289102	COIL, PEAKING, TRF4102AF
L731	23237805	COIL, PEAKING, TRF4222AC
L737	23289560	COIL, PEAKING, TRF4560AF
L738	23289560	COIL, PEAKING, TRF4560AF
L739	23289560	COIL, PEAKING, TRF4560AF
L740	23289560	COIL, PEAKING, TRF4560AF
L750	23103887	INDUCTOR, CHIP BEAD, TEM2130AM
L753	23103828	INDUCTOR, BEAD, TEM2121M
L754	23103828	INDUCTOR, BEAD, TEM2121M
L778	23103828	INDUCTOR, BEAD, TEM2121M
L779	23103828	INDUCTOR, BEAD, TEM2121M
L780	23103828	INDUCTOR, BEAD, TEM2121M
L781	23103828	INDUCTOR, BEAD, TEM2121M
L782	23103828	INDUCTOR, BEAD, TEM2121M
L783	23103828	INDUCTOR, BEAD, TEM2121M
L793	23248288	COIL, CHOKE, TLN3299GH
L794	23248288	COIL, CHOKE, TLN3299GH
L802	23103880	COIL, CHOKE, TEM2011Y
L803	23103880	COIL, CHOKE, TEM2011Y
L804	23103880	COIL, CHOKE, TEM2011Y
L823	23248288	COIL, CHOKE, TLN3299GH
L824	23248288	COIL, CHOKE, TLN3299GH
L840	23248288	COIL, CHOKE, TLN3299GH
L842	23103880	COIL, CHOKE, TEM2011Y
L853	23248288	COIL, CHOKE, TLN3299GH
L856	23103859	FILTER, FERRITE CHOKE, TEM2011
L857	23103859	FILTER, FERRITE CHOKE, TEM2011
L858	23103859	FILTER, FERRITE CHOKE, TEM2011
L859	23103859	FILTER, FERRITE CHOKE, TEM2011
L861	23103859	FILTER, FERRITE CHOKE, TEM2011
L862	23248288	COIL, CHOKE, TLN3299GH
L863	23103859	FILTER, FERRITE CHOKE, TEM2011
L866	23248288	COIL, CHOKE, TLN3299GH
L868	23103859	FILTER, FERRITE CHOKE, TEM2011
L869	23103859	FILTER, FERRITE CHOKE, TEM2011
L871	23280019	COIL, PEAKING, TRF4330AZ
L961	23289100	COIL, PEAKING, TRF4100AF
L962	23237991	COIL, PEAKING, TRF4479AC
L963	23237975	COIL, PEAKING, TRF4101AC
L4401	23289840	COIL, PEAKING, TRF4100AT
L4471	23289840	COIL, PEAKING, TRF4100AT
LA02	23103828	INDUCTOR, BEAD, TEM2121M
LA04	23103828	INDUCTOR, BEAD, TEM2121M
LA05	23103828	INDUCTOR, BEAD, TEM2121M
LA39	23103828	INDUCTOR, BEAD, TEM2121M
LC01	23103828	INDUCTOR, BEAD, TEM2121M
LC02	23103828	INDUCTOR, BEAD, TEM2121M
LC03	23103828	INDUCTOR, BEAD, TEM2121M
LC04	23103828	INDUCTOR, BEAD, TEM2121M
LC05	23103828	INDUCTOR, BEAD, TEM2121M
LC06	23103828	INDUCTOR, BEAD, TEM2121M
LC07	23238562	COIL, PEAKING, TRF4109AJ
LC08	23238562	COIL, PEAKING, TRF4109AJ
LC11	23103852	COIL, FILTER, TEM2028AH
LC12	23238562	COIL, PEAKING, TRF4109AJ
LC15	23103828	INDUCTOR, BEAD, TEM2121M
LC16	23103828	INDUCTOR, BEAD, TEM2121M
LC17	23103828	INDUCTOR, BEAD, TEM2121M
LR01	23289840	COIL, PEAKING, TRF4100AT
LR22	23103146	EMI FILTER, TEM2030AA
LR23	23103146	EMI FILTER, TEM2030AA
LV09	23289840	COIL, PEAKING, TRF4100AT
LV43	23289840	COIL, PEAKING, TRF4100AT
LV49	23103852	COIL, FILTER, TEM2028AH
LW02	23261974	COIL, FERRITE BEAD, HC5-035

Location No.	Parts No.	Description
LW04	23103859	FILTER, FERRITE CHOKE, TEM2011
LW05	23103859	FILTER, FERRITE CHOKE, TEM2011
T400	23224364	TRANSFORMER, FOCUS, TLN2168AH
T401	23224367	TRANSFORMER, HORIZ DRIVER, TLN1098AH
△ T461	23236701	TRANSFORMER, FLYBACK, TFB3091BH
T461A	23192961	ANODE CAP ASSY, TCC5605AU
T801	23211736	COIL, LINE FILTER, TRF3231AL
T802	23217603	TRANSFORMER, CHOKE 52MH 1.05, TPW2049AT
△ T862	23217463	TRANSFORMER, CONVERTER, TPW3447AS
<b>SEMICONDUCTORS</b>		
Q101	23114815	TRANSISTOR, 2SC388ATM(FA)
Q102	23114815	TRANSISTOR, 2SC388ATM(FA)
Q104	23114497	TRANSISTOR, RN1406
Q105	23314993	TRANSISTOR, 2SC4081 Q
Q106	23314993	TRANSISTOR, 2SC4081 Q
Q107	23314994	TRANSISTOR, 2SA1576A106
Q120	23114497	TRANSISTOR, RN1406
Q121	70114396	TRANSISTOR, 2SC3326B
Q201	23114433	TRANSISTOR, 2SC1815-Y
Q202	23314994	TRANSISTOR, 2SA1576A106
Q203	23314994	TRANSISTOR, 2SA1576A106
Q204	23314994	TRANSISTOR, 2SA1576A106
Q241	23114755	TRANSISTOR, 2SC2482FA-1
Q274	23314993	TRANSISTOR, 2SC4081 Q
Q301	23009294	IC, VERT. DEF. OUT TO-220-7H, LA78040
Q301B	70391355	SCREW, BIND HEAD TAP-TITE B, BITTB 3X8 SZN
Q304	70119059	IC, OP AMP, TA75902P(J)
Q330	70129117	IC, TA75902FB
Q370	23205116	TRANSISTOR, 2SC5343UF-Y(B)
Q371	23205112	TRANSISTOR, 2SA1980UF-Y(
Q372	23205116	TRANSISTOR, 2SC5343UF-Y(B)
Q400	23205079	TRANSISTOR, 2SC4686A
Q402	23114755	TRANSISTOR, 2SC2482FA-1
Q404	23314955	TRANSISTOR, 2SD2553(FA)
Q404B	72471082	SCREW, 3X10MM
Q405	23114437	TRANSISTOR, 2SC752GTM-Y
Q406	23114437	TRANSISTOR, 2SC752GTM-Y
Q407	23114433	TRANSISTOR, 2SC1815-Y
Q408	23114425	TRANSISTOR, 2SA1015-Y(TE
Q409	23114433	TRANSISTOR, 2SC1815-Y
Q420	23114756	TRANSISTOR, 2SC2482
Q425	23205031	TRANSISTOR, FET, 2SK2920
Q426	23119747	IC, OPE AMP, TA75358P
Q427	70128158	IC, BA10393
Q482	23114433	TRANSISTOR, 2SC1815-Y
Q492	23314359	TRANSISTOR, 2SA1321(FA, C)
Q501	23009286	IC, PAL/NTSC/SECAM 1CHIP, TB1262F
Q504	23205112	TRANSISTOR, 2SA1980UF-Y(
Q505	23205112	TRANSISTOR, 2SA1980UF-Y(
Q610	23000269	IC, TA8216H
Q610B	70391355	SCREW, BIND HEAD TAP-TITE B, BITTB 3X8 SZN
Q611	70114396	TRANSISTOR, 2SC3326B
Q612	70114396	TRANSISTOR, 2SC3326B
Q614	23114499	TRANSISTOR, RN1404
Q616	23205112	TRANSISTOR, 2SA1980UF-Y(
Q617	23906596	IC, BA4558
Q701	23000380	IC, TC190C060AF-301(Z)
Q703	23319396	IC, UPD6376GS
Q704	23319396	IC, UPD6376GS
Q707	23905013	IC, TLC2932IPW
Q709	23906908	IC, MC33078D
Q711	23009328	IC, 16K BIT CMOS EEPROM,

Location No.	Parts No.	Description
Q712	23009328	AT24C16-10PI-2.7 IC, 16K BIT CMOS EEPROM,
Q715	23906908	AT24C16-10PI-2.7 IC, MC33078D
Q7164	23319720	IC, TC74HC14AF
Q717	23906908	IC, MC33078D
Q719	23906908	IC, MC33078D
Q735	23000140	IC, MM1437AS
Q750	23000928	IC, SLA4501M
Q750	23319396	IC, UPD6376GS
Q750B	23035310	SCREW, BTB3X10SZN
Q751	23000928	IC, SLA4501M
Q751B	23035310	SCREW, BTB3X10SZN
Q753	23000928	IC, SLA4501M
Q753B	23035310	SCREW, BTB3X10SZN
Q755	23904525	IC, AN7809
Q756	23318841	IC, AN79M09F
Q756B	23035310	SCREW, BTB3X10SZN
Q761	70119306	IC, TA75393P
Q762	23000044	IC, TC4066BP(N)
Q798	23114433	TRANSISTOR, 2SC1815-Y
Q801	23906540	IC, STR-Z4267
Q830	23905977	IC, PQ09RD11
Q830	23114458	TRANSISTOR, RN1206
Q830B	70391355	SCREW, BIND HEAD TAP-TITE B, BITTB 3X8 SZN
Q831	23114433	TRANSISTOR, 2SC1815-Y
Q832	23905976	IC, PQ05RD11
Q832	23114433	TRANSISTOR, 2SC1815-Y
Q832B	70391355	SCREW, BIND HEAD TAP-TITE B, BITTB 3X8 SZN
Q833	23114433	TRANSISTOR, 2SC1815-Y
Q834	23114425	TRANSISTOR, 2SA1015-Y(TE
△ Q862	23906427	IC, PHOTO COUPLER, TLP721F(D4-GR
Q863	23319305	IC, SE140N
Q901	23314971	TRANSISTOR, 2SC5360(FA)
Q902	23114433	TRANSISTOR, 2SC1815-Y
Q911	23314971	TRANSISTOR, 2SC5360(FA)
Q913	23114433	TRANSISTOR, 2SC1815-Y
Q921	23314971	TRANSISTOR, 2SC5360(FA)
Q922	23114433	TRANSISTOR, 2SC1815-Y
Q961	23114433	TRANSISTOR, 2SC1815-Y
Q962	23114422	TRANSISTOR, 2SA562TM-Y
Q963	23114433	TRANSISTOR, 2SC1815-Y
Q964	23114425	TRANSISTOR, 2SA1015-Y(TE
Q965	23114433	TRANSISTOR, 2SC1815-Y
Q966	23114425	TRANSISTOR, 2SA1015-Y(TE
Q4451	23205116	TRANSISTOR, 2SC5343UF-Y(B)
Q4452	23114497	TRANSISTOR, RN1406
Q4453	23114497	TRANSISTOR, RN1406
Q4454	23114497	TRANSISTOR, RN1406
Q4471	23314164	TRANSISTOR, 2SC2236-Y(C))
Q9601	23114425	TRANSISTOR, 2SA1015-Y(TE
Q9602	23114425	TRANSISTOR, 2SA1015-Y(TE
Q9605	23114433	TRANSISTOR, 2SC1815-Y
Q9606	23114425	TRANSISTOR, 2SA1015-Y(TE
QA01	23009203	IC, 8BIT TV/TEXT MCU 96K MASK, SAA5564PS/M3/0705
QA01	23009430	IC, 8BIT TV/TEXT MCU 64K MASK, SAA5563PS/M3/0705
QA02	23009328	IC, 16K BIT CMOS EEPROM, AT24C16-10PI-2.7
QA03	23000283	IC, R1121N
QA05	23009291	IC, RESET 4.0V SMP5, BD4740G-TR
QA06	23205112	TRANSISTOR, 2SA1980UF-Y(
QA07	23205112	TRANSISTOR, 2SA1980UF-Y(
QA08	23205112	TRANSISTOR, 2SA1980UF-Y(

Location No.	Parts No.	Description
QA09	23114499	TRANSISTOR, RN1404
QA10	70114402	TRANSISTOR, 2SC3437-Y
QA11	23114501	TRANSISTOR, RN1402
QA12	23205112	TRANSISTOR, 2SA1980UF-Y(
QA13	23205112	TRANSISTOR, 2SA1980UF-Y(
QA61	23114497	TRANSISTOR, RN1406
QB01	23205112	TRANSISTOR, 2SA1980UF-Y(
QB01	23114433	TRANSISTOR, 2SC1815-Y
QB02	23314993	TRANSISTOR, 2SC4081 Q
QB03	23205112	TRANSISTOR, 2SA1980UF-Y(
QR01	70128711	IC, SW 2IN 1OUT 3CIRCUIT ALLCLP, BA7603F
QR03	23314993	TRANSISTOR, 2SC4081 Q
QR04	23114501	TRANSISTOR, RN1402
QR36	23205116	TRANSISTOR, 2SC5343UF-Y(B
QR38	23205116	TRANSISTOR, 2SC5343UF-Y(B
QR40	23205116	TRANSISTOR, 2SC5343UF-Y(B
QS01	70114396	TRANSISTOR, 2SC3326B
QS02	70114396	TRANSISTOR, 2SC3326B
QS05	70114396	TRANSISTOR, 2SC3326B
QS06	70114396	TRANSISTOR, 2SC3326B
QS09	23114493	TRANSISTOR, RN2404
QV01	23000368	IC, MM1495XF
QV03	23314993	TRANSISTOR, 2SC4081 Q
QV09	23114433	TRANSISTOR, 2SC1815-Y
QV12	23114433	TRANSISTOR, 2SC1815-Y
QV14	23114433	TRANSISTOR, 2SC1815-Y
QW06	23114433	TRANSISTOR, 2SC1815-Y
QW07	23114437	TRANSISTOR, 2SC752GTM-Y
QW09	23114433	TRANSISTOR, 2SC1815-Y
QW10	23114425	TRANSISTOR, 2SA1015-Y(TE
QW19	23114433	TRANSISTOR, 2SC1815-Y
QW20	23114433	TRANSISTOR, 2SC1815-Y
QW51	23314909	TRANSISTOR, 2SA1837
QW52	23314912	TRANSISTOR, 2SC4793
D101	23357219	DIODE, 1SS400
D102	23316755	DIODE, ZENER, MTZJ33C
D104	23118138	DIODE, MA77
D201	23118041	DIODE, MA111
D301	23316678	DIODE, ZENER, MTZJ6.8B
D302	23357365	DIODE, 1N4004A-B5
D304	23316794	DIODE, SC570A
D308	23316583	DIODE, ZENER, MA8039-H
D310	23115599	DIODE, 1N4148
D370	23357219	DIODE, 1SS400
D401	23118094	DIODE, EU2A
D402	23118094	DIODE, EU2A
D403	23316254	DIODE, ERC06-15
D405	23316254	DIODE, ERC06-15
D406	23115910	DIODE, S5295G
D410	23357365	DIODE, 1N4004A-B5
D412	23118707	DIODE, RP-1H
D413	23118707	DIODE, RP-1H
D420	23115599	DIODE, 1N4148
D421	23357365	DIODE, 1N4004A-B5
D425	23118094	DIODE, EU2A
D426	23316731	DIODE, ZENER, MTZJ18B
D461	23316969	DIODE, ERD29-06
D490	23115599	DIODE, 1N4148
D490	23316675	DIODE, ZENER, MTZJ6.2B
D491	23115599	DIODE, 1N4148
D491	23316758	DIODE, ZENER, MTZJ36B
D492	23316690	DIODE, ZENER, MTZJ10B
D505	23115599	DIODE, 1N4148
D511	23357037	DIODE, ZENER, UDZS5.6B
D512	23357037	DIODE, ZENER, UDZS5.6B
D513	23357037	DIODE, ZENER, UDZS5.6B

Location No.	Parts No.	Description
D601	23357219	DIODE, 1SS400
D602	23357219	DIODE, 1SS400
D603	23357219	DIODE, 1SS400
D604	23357219	DIODE, 1SS400
D608	23357219	DIODE, 1SS400
D609	23357219	DIODE, 1SS400
D610	23357219	DIODE, 1SS400
D611	23357219	DIODE, 1SS400
D628	23118269	DIODE, ZENER, RD22MB2
D701	23357219	DIODE, 1SS400
D702	23357219	DIODE, 1SS400
D703	23357219	DIODE, 1SS400
D704	23357219	DIODE, 1SS400
D705	23316675	DIODE, ZENER, MTZJ6.2B
D706	23316675	DIODE, ZENER, MTZJ6.2B
D707	23316675	DIODE, ZENER, MTZJ6.2B
D802	23357041	DIODE, LN6SB60-F05
D816	24000656	VARISTOR, TNR15G471K
D820	23316757	DIODE, ZENER, MTZJ36A
D821	23115599	DIODE, 1N4148
D829	23316711	DIODE, S1WBA60
D830	23357365	DIODE, 1N4004A-B5
D830	23115599	DIODE, 1N4148
D832	23357365	DIODE, 1N4004A-B5
D832	23118529	DIODE, ZENER, RD5.6ES B2
D841	23316677	DIODE, ZENER, MTZJ6.8A
D845	23357215	DIODE, D4SBS6
D845B	70391355	SCREW, BIND HEAD TAP-TITE B, BITTB 3X8 SZN
D854	23357214	DIODE, D4SBS4
D856	23357216	DIODE, D4SBL20U
D858	23115599	DIODE, 1N4148
D860	23357217	DIODE, D4SBL40
D862	23118057	DIODE, AG01A
D863	23316689	DIODE, ZENER, MTZJ10A
D864	23118060	DIODE, AL01Z
D873	23118615	DIODE, ZENER, RD27ES B3
D875	23118516	DIODE, ZENER, RD9.1ES B3
D876	23316753	DIODE, ZENER, MTZJ33A
D877	23118615	DIODE, ZENER, RD27ES B3
D878	23118518	DIODE, ZENER, RD9.1ES
D879	23118633	DIODE, ZENER, RD3.0ES B2
D880	23118633	DIODE, ZENER, RD3.0ES B2
D901	23115599	DIODE, 1N4148
D902	23115599	DIODE, 1N4148
D911	23115599	DIODE, 1N4148
D912	23115599	DIODE, 1N4148
D921	23115599	DIODE, 1N4148
D922	23115599	DIODE, 1N4148
D924	23115599	DIODE, 1N4148
D925	23115599	DIODE, 1N4148
D965	23115599	DIODE, 1N4148
D966	23115599	DIODE, 1N4148
D4401	23357219	DIODE, 1SS400
D4402	23357219	DIODE, 1SS400
D4420	23357219	DIODE, 1SS400
D4451	23357365	DIODE, 1N4004A-B5
D4452	23316585	DIODE, ZENER, MA8082-M
D4453	23357219	DIODE, 1SS400
D4471	23316690	DIODE, ZENER, MTZJ10B
D7105	23357219	DIODE, 1SS400
D7106	23357219	DIODE, 1SS400
D7107	23357219	DIODE, 1SS400
D7108	23357219	DIODE, 1SS400
D7303	23118538	DIODE, ZENER, RD6.2ESA B2
D7304	23118618	DIODE, ZENER, RD20ES B3
D7710	23316716	DIODE, ZENER, MTZJ11B

Location No.	Parts No.	Description
D7711	23316716	DIODE, ZENER, MTZJ11B
D7713	23115599	DIODE, 1N4148
D7736	23115599	DIODE, 1N4148
D7743	23115532	DIODE, ERB12-01
D7744	23115532	DIODE, ERB12-01
DA04	23357219	DIODE, 1SS400
DA05	23357219	DIODE, 1SS400
DA06	23357037	DIODE, ZENER, UDZS5.6B
DB01	23358564	DIODE, LED, SLR-56VC3FPQ
DR06	23357219	DIODE, 1SS400
DR07	23357219	DIODE, 1SS400
DR70	23357037	DIODE, ZENER, UDZS5.6B
DW04	23115599	DIODE, 1N4148
DW05	23115599	DIODE, 1N4148
DW21	23115599	DIODE, 1N4148
<b>MISCELLANEOUS</b>		
B224	23035412	SCREW, BTB4X12SZN
B230	23037312	SCREW, BTBW3X12SZN
B231	23845856	WIRE CLAMP, POF COAT) L=70MM
B232	23035412	SCREW, BTB4X12SZN
B233	23845856	WIRE CLAMP, POF COAT) L=70MM
B236	23037312	SCREW, BTBW3X12SZN
B238	23845856	WIRE CLAMP, POF COAT) L=70MM
B239	23035412	SCREW, BTB4X12SZN
B240	23035412	SCREW, BTB4X12SZN
BB21A	23713013	BASE SOCKET 16P 1.5
BB21B	23713014	CONNECTOR, BRIDGE PLUG 16P 1.5
BB23A	23903022	CONNECTOR, BASE B-B 8P 2.5 JST
BB23B	23903022	CONNECTOR, BASE B-B 8P 2.5 JST
BB23C	23368627	CONNECTOR, BRIDGE B-B 8P 2.5JST 08TM-2.5FJ-E
BB24A	23713013	BASE SOCKET 16P 1.5
BB24B	23713014	CONNECTOR, BRIDGE PLUG 16P 1.5
BB71A	23713013	BASE SOCKET 16P 1.5
BB71B	23713014	CONNECTOR, BRIDGE PLUG 16P 1.5
BB80A	23713013	BASE SOCKET 16P 1.5
BB80B	23713014	CONNECTOR, BRIDGE PLUG 16P 1.5
BB82A	23713013	BASE SOCKET 16P 1.5
BB82B	23713014	CONNECTOR, BRIDGE PLUG 16P 1.5
BB85A	23903022	CONNECTOR, BASE B-B 8P 2.5 JST
BB85B	23903022	CONNECTOR, BASE B-B 8P 2.5 JST
BB85C	23368627	CONNECTOR, BRIDGE B-B 8P 2.5JST 08TM-2.5FJ-E
E921	23964147	COOLANT, COOLANT
E951	23964147	COOLANT, COOLANT
E981	23964147	COOLANT, COOLANT
△ F801	23144507	FUSE, CARTRIDGE 5.2X20, 250V 3.15A
F801A	23165433	FUSE HOLDER, 5.2 SOC
F801B	23165433	FUSE HOLDER, 5.2 SOC
G005	23115599	DIODE, 1N4148
G023	24327180	RESISTOR, METAL FILM, 1/4W 180 OHM F
G101	24011123	CHIP, METAL FILM, 1/20W 12K OHM J
G103	23103828	INDUCTOR, BEAD, TEM2121M
G104	23103828	INDUCTOR, BEAD, TEM2121M
G105	24000445	CHIP JUMPER, 1608TYPE
G601	24000445	CHIP JUMPER, 1608TYPE
G602	24000445	CHIP JUMPER, 1608TYPE
G603	24000445	CHIP JUMPER, 1608TYPE
G604	24000445	CHIP JUMPER, 1608TYPE
G7173	24000445	CHIP JUMPER, 1608TYPE
G7174	24000445	CHIP JUMPER, 1608TYPE
GA26	23103828	INDUCTOR, BEAD, TEM2121M
GC01	24000445	CHIP JUMPER, 1608TYPE
GC02	24000445	CHIP JUMPER, 1608TYPE
GC03	24000445	CHIP JUMPER, 1608TYPE
GC15	24000445	CHIP JUMPER, 1608TYPE

Location No.	Parts No.	Description
GC16	24000445	CHIP JUMPER, 1608TYPE
GC17	24000445	CHIP JUMPER, 1608TYPE
GJ11	24000445	CHIP JUMPER, 1608TYPE
GJ21	24000445	CHIP JUMPER, 1608TYPE
GJ22	24000445	CHIP JUMPER, 1608TYPE
GJ23	24000445	CHIP JUMPER, 1608TYPE
GJ24	24000445	CHIP JUMPER, 1608TYPE
GJ30	24000445	CHIP JUMPER, 1608TYPE
GJ31	24000824	CHIP JUMPER, 2125TYPE
GJ32	24000824	CHIP JUMPER, 2125TYPE
GJ33	24000445	CHIP JUMPER, 1608TYPE
GJ34	24000445	CHIP JUMPER, 1608TYPE
GJ35	24000445	CHIP JUMPER, 1608TYPE
GJ62	24000445	CHIP JUMPER, 1608TYPE
GJ63	24000445	CHIP JUMPER, 1608TYPE
GJ68	24000445	CHIP JUMPER, 1608TYPE
GJ101	24000445	CHIP JUMPER, 1608TYPE
GJ440	24000824	CHIP JUMPER, 2125TYPE
GJ705	24000445	CHIP JUMPER, 1608TYPE
GJ707	24000445	CHIP JUMPER, 1608TYPE
GJ708	24000445	CHIP JUMPER, 1608TYPE
GJ712	24000445	CHIP JUMPER, 1608TYPE
GJ713	24000445	CHIP JUMPER, 1608TYPE
GJ714	24000445	CHIP JUMPER, 1608TYPE
GJ718	24000445	CHIP JUMPER, 1608TYPE
H002	23148745	MODULE, NICAM/IGR A-PRO, MPSN11C
J501B	23960136	ADHESIVE, SILICONE, TSE3843-W
KB01	23000852	IC, REMOCON RECEIVER, PIC-37043TE2
P661	23365444	CONNECTOR, EARPONE JACK, D3.5 HOSIDEN
P703	23164786	CONNECTOR, PLUG 6P
P713	23164787	CONNECTOR, PLUG, 7P
P714	23164787	CONNECTOR, PLUG, 7P
P715	23164787	CONNECTOR, PLUG, 7P
P800	23368013	CONNECTOR, PLUG, 2P 11.88MM W VT-JST
△ P801	23372012	POWER CORD
PH02	23365598	CONNECTOR, 21 PIN, 2100RFT
△ S801	23344482	SWITCH, ESB92S NAE, ESB92S28B
SA01	23145430	SWITCH, PUSH, SKHHLMA010
SA02	23145430	SWITCH, PUSH, SKHHLMA010
SA03	23145430	SWITCH, PUSH, SKHHLMA010
SA04	23145430	SWITCH, PUSH, SKHHLMA010
SA06	23145430	SWITCH, PUSH, SKHHLMA010
△ SR81	23146574	RELAY, DLS5D1-O(M) 0.15W
△ V901A	23903148	SOCKET, ISH-44S-E ICE #5
△ V902A	23903148	SOCKET, ISH-44S-E ICE #5
△ V903A	23903148	SOCKET, ISH-44S-E ICE #5
W661	23151232	SPEAKER, SPK-1235, 160X160, 65HZ, 8 OHM
W662	23151232	SPEAKER, SPK-1235, 160X160, 65HZ, 8 OHM
X501	23153979	CRYSTAL, 4.43MHZ PAL-APC
XA01	23153930	CRYSTAL, 12.000 25PPM 40OHM 7PF
Z101	23303295	FILTER, FILTER, VIDEO 38.9M, K3958M
Z102	23303296	FILTER, FILTER, FOR AUDIO 33.9, K9650M
Z103	23303106	CERAMIC TRAP, TCF1094
Z104	23303189	CERAMIC TRAP, TCF1114
△ Z410	23110842	FOCUS PACK, TPA6031
△ Z450	24083013	COMPOSITE PARTS, CR-BLOCK, TPA5010AH
Z450A	23501755	ANODE CABLE, 400LD FBT-C
Z702	23103823	COIL, FILTER, TEM2027D
Z703	23103823	COIL, FILTER, TEM2027D
Z704	23103823	COIL, FILTER, TEM2027D
Z705	23103823	COIL, FILTER, TEM2027D
Z706	23103823	COIL, FILTER, TEM2027D
Z707	23103823	COIL, FILTER, TEM2027D
Z711	23103823	COIL, FILTER, TEM2027D
Z712	23103823	COIL, FILTER, TEM2027D

Location No.	Parts No.	Description
△ Z803	23148029	MODULE, DC/DC CONVERTER, UPM0508SA
△ Z831	23144603	PROTECTOR, PRT SERIES, DC60V/AC90V 1000MA
△ Z853	23144608	PROTECTOR, PRT SERIES, DC60V/AC90V 4000MA
△ Z856	23144605	PROTECTOR, PRT SERIES, DC60V/AC90V 2000MA
△ Z857	23144607	PROTECTOR, PRT SERIES, DC60V/AC90V 3150MA
△ Z858	23144609	PROTECTOR, PRT SERIES, DC60V/AC90V 5000MA
△ Z859	23144609	PROTECTOR, PRT SERIES, DC60V/AC90V 5000MA
△ Z860	23144480	PROTECTOR, CURRENT, AC125V 3.15A
Z7001	24019400	CHIP BLOCK, 1/16W 100 OHM J P-8
Z7002	24019400	CHIP BLOCK, 1/16W 100 OHM J P-8
<b>PC BOARD ASSEMBLIES</b>		
* U901A	23787876	CRTD R BOARD, PD0820A-1
* U901B	23787878	CRTD G BOARD, PD0820A-2
* U901C	23787879	CRTD B BOARD, PD0820A-3
* U901D	23787880	F-AV/KEY BOARD, PD0820A-4
* U901E	23787881	RMT BOARD, PD0820A-5
* U901F	23787882	LED BOARD, PD0820A-6
* U901G	23787883	SVM BOARD, PD0820A-7
* U902	23787873	SIGNAL BOARD, PD0817A
* U903	23787875	POWER BOARD, PD0819A
* U904	23787874	DEF/CONV BOARD, PD0818A
<b>PICTURE TUBE</b>		
△ V911R	23588829	SERVICE KIT, SERVICE KIT CRT-R 43VJ22P
△ V912B	23588830	SERVICE KIT, SERVICE KIT CRT-G 43VJ22P
△ V913G	23588831	SERVICE KIT, SERVICE KIT CRT-B 43VJ22P
<b>TUNER</b>		
H001	23321449	TUNER, HYP.EMULT ICPL D-J ALPS, TEDE9-243A
<b>ACCESSORIES</b>		
K902	23306435	REMOCON HAND UNIT IR, CTVPAL, CT-90101
Y101A	23565718	OWNER'S MANUAL, ENGLISH, 43VJ22P
Y101B	23565719	OWNER'S MANUAL, FRENCH, 43VJ22P
Y101C	23565720	OWNER'S MANUAL, GERMANY, 43VJ22P
Y101D	23565721	OWNER'S MANUAL, ITALIAN, 43VJ22P
Y101E	23565722	OWNER'S MANUAL, SPANISH, 43VJ22P
Y101F	23565724	OWNER'S MANUAL, DEN, 43VJ22P
Y101G	23565725	OWNER'S MANUAL, SWEDISH, 43VJ22P
Y101H	23565726	OWNER'S MANUAL, FINNISH, 43VJ22P
Y101I	23565727	OWNER'S MANUAL, NORWEGIAN, 43VJ22P
Y101J	23565728	OWNER'S MANUAL, DUTCH, 43VJ22P
Y101K	23565723	OWNER'S MANUAL, PORTUGUES, 43VJ22P
Y101L	23565729	OWNER'S MANUAL, POLISH, 43VJ22P
Y101M	23565730	OWNER'S MANUAL, TRK, 43VJ22P
<b>CABINET PARTS</b>		
A125	23560038	LABEL, ATTENTION SERVICE 48PJ6DB
A201	23530449	COVER, BEZEL 43VJ22P
A223	23445657	BUTTON, BUTTON POWER 43VJ22P
A222	23929787	PIECE, BUTTON POWER, 43VJ22P
A258	23527238	GRILLE, SPEAKER GRILLE 43VJ22P
A420	23540149	BACK COVER PROPER, 43PJ93B
△ A424	23411739	CABINET, BACK BOARD 43VJ22P
A501	23035412	SCREW, BTB4X12SZN
A505	72471068	SCREW, 4X12
A508	23035412	SCREW, BTB4X12SZN
A529	23037312	SCREW, BTBW3X12SZN
A529	23037312	SCREW, BTBW3X12SZN

Location No.	Parts No.	Description
A543	72471068	SCREW, 4X12
A547	23035010	SCREW, PBI 4X16
A701	23064552	CARTON, CASE 43PH14P
A702	23935878	PACKING, BOTTOM PACKING 43PJ93B;A985384E
A703	23935880	PACKING, TOP PACKING 43PJ93B;A985385E
A726	23974753	POLYPROPYLENE BAND, 3327DB
A727	23974753	POLYPROPYLENE BAND, 3327DB
A731D	23560820	LABEL,IN HOUSE CARTON(57YEL), 28MW7DB
K101	23405101	LENS, DELTA71-A/B, DELTA71-A/B
K102	23405101	LENS, DELTA71-A/B, DELTA71-A/B
K103	23405101	LENS, DELTA71-A/B, DELTA71-A/B
K501	23430786	SCREEN, 43KK LENTICULAR SHEET, SCREEN43KK-L
K502	23430902	SCREEN, 43KKK FRESNEL SHEET, SCREEN43KKKF
K601	23430758	MIRROR, 43KE 860/580x600/75x2.3, MIRROR43KE

**THIS PAGE IS  
INTENTIONALLY LEFT  
BLANK.**



SIGNAL BOARD PD0817A  
BOTTOM (FOIL) SIDE

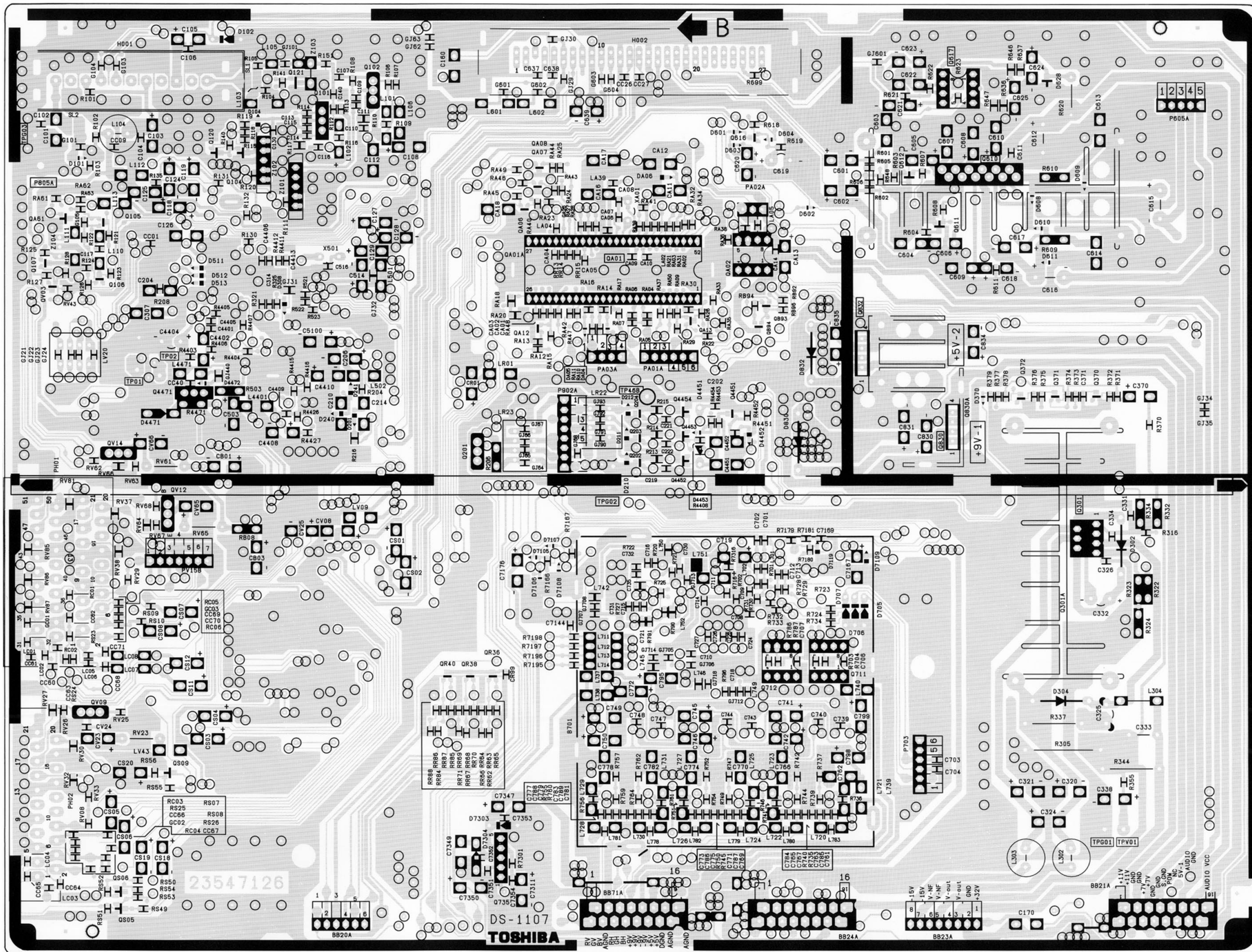

DEF/CONV BOARD PD818A  
 BOTTOM (FOIL) SIDE

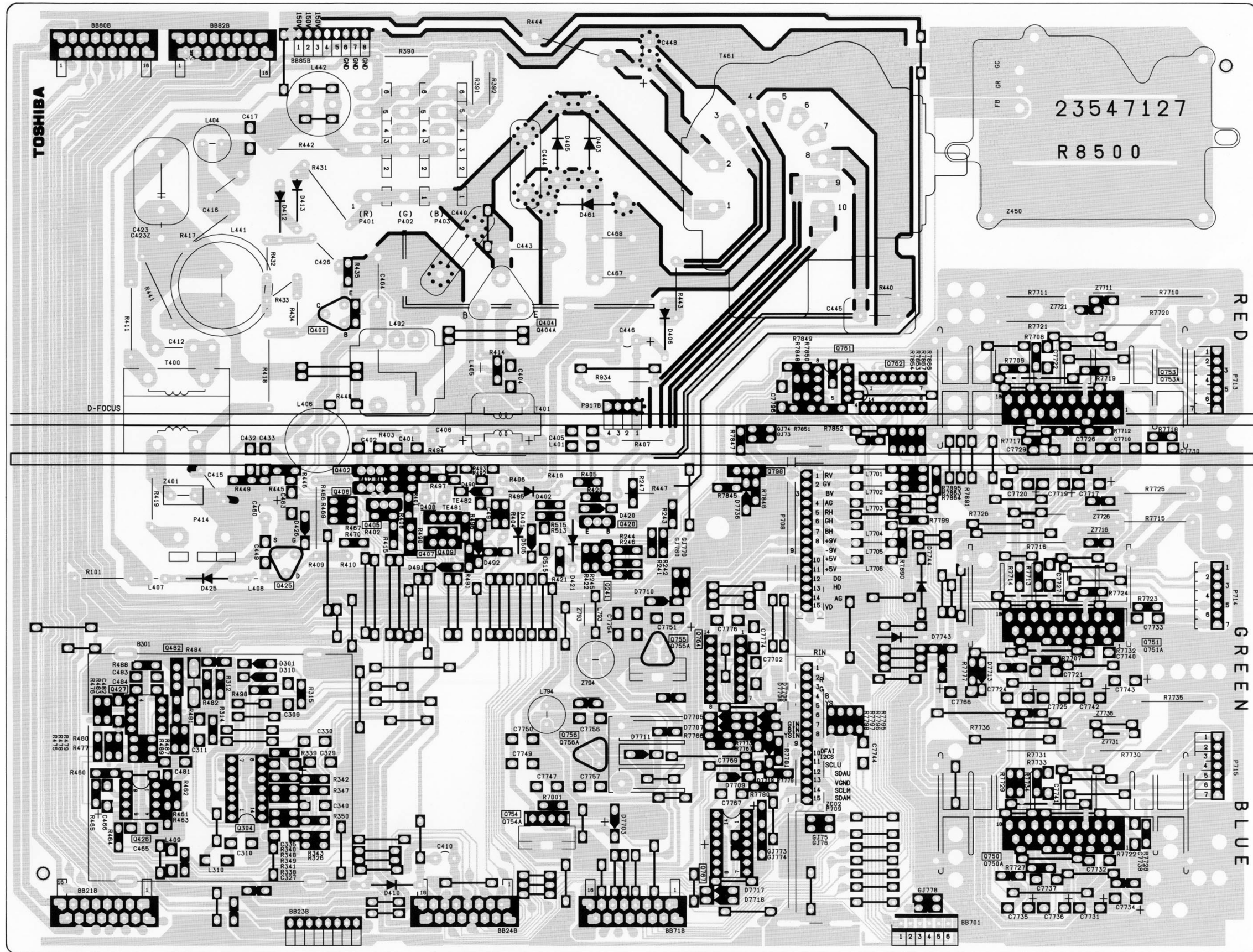

POWER BOARD PD0819A  
BOTTOM (FOIL) SIDE

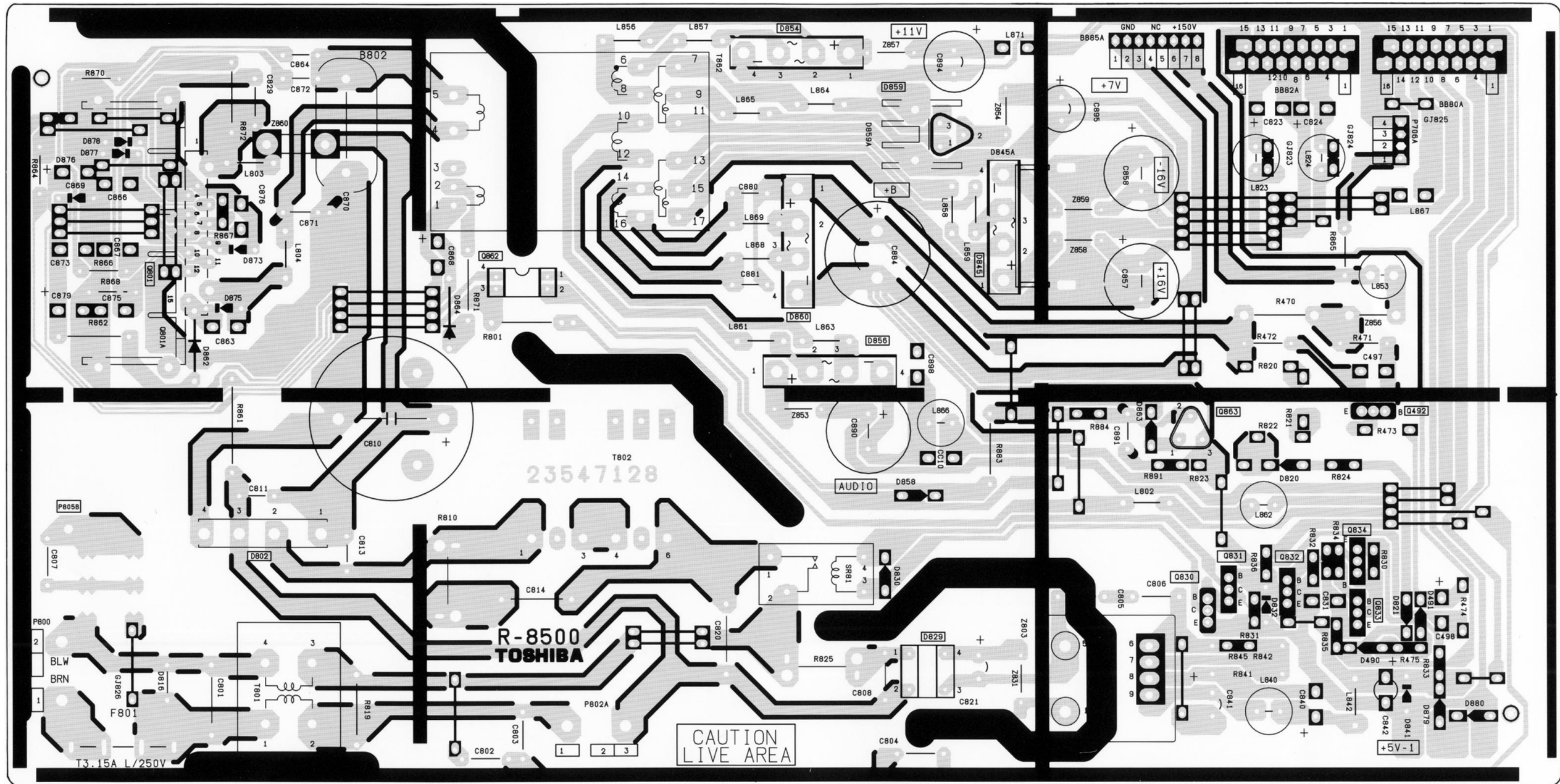

**CRD-D R BOARD PD0820A-1**  
BOTTOM (FOIL) SIDE

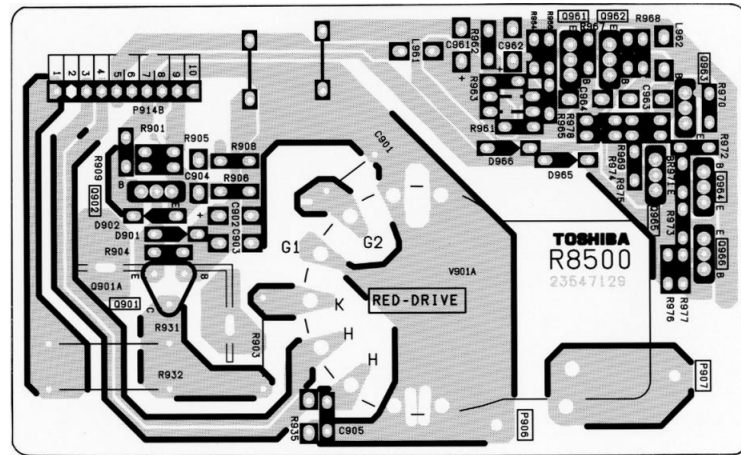

**F-AV/KEY BOARD PD0820A-4**  
BOTTOM (FOIL) SIDE

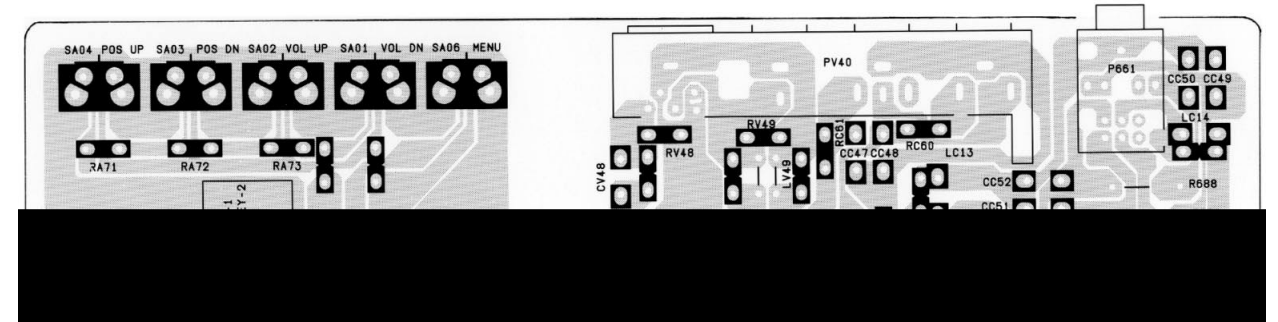

**CRD-D G BOARD PD0820A-2**  
BOTTOM (FOIL) SIDE

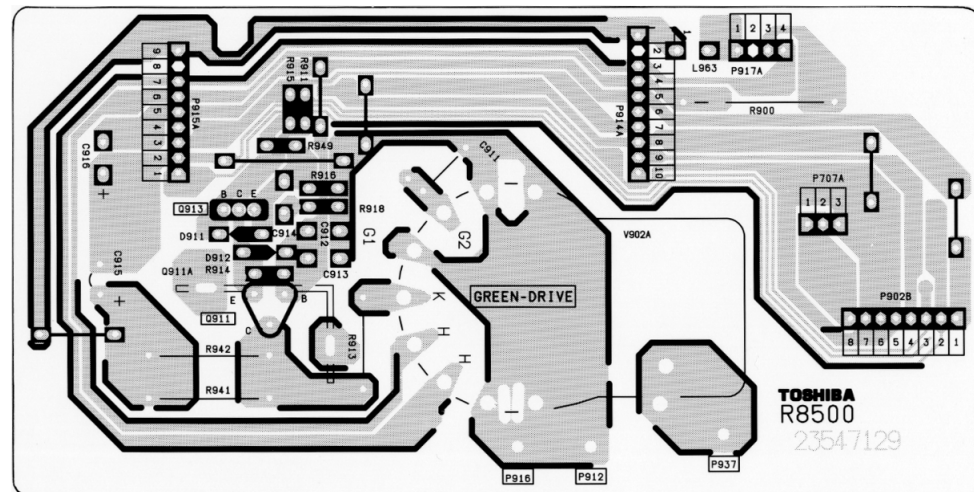

**RMT BOARD PD0820A-5**  
BOTTOM (FOIL) SIDE

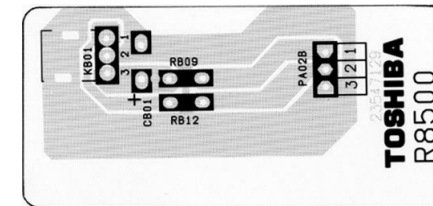

**LED BOARD PD0820A-6**  
BOTTOM (FOIL) SIDE

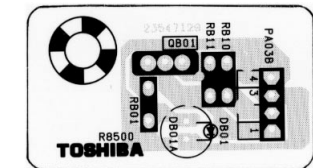

**CRD-D B BOARD PD0820A-3**  
BOTTOM (FOIL) SIDE



**SVM BOARD PD820A-7**  
BOTTOM (FOIL) SIDE

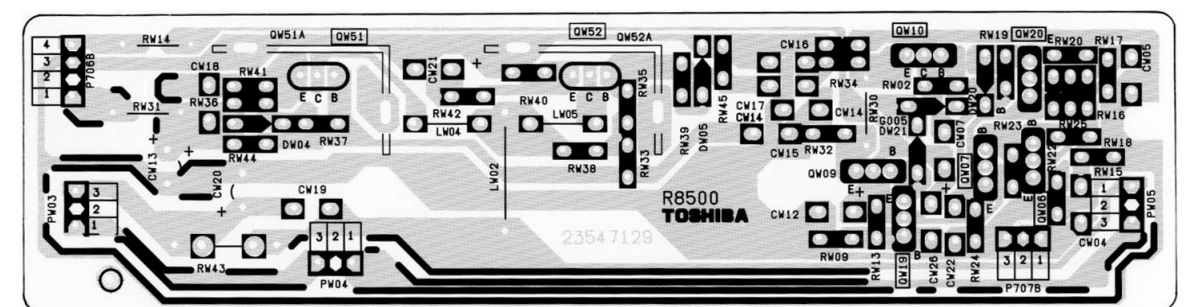

## TERMINAL VIEW OF TRANSISTORS

① 2SD2253  
(old)  
2SC5243

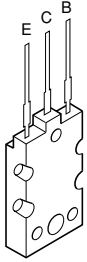

② 2SC3852  
2SD1763A  
2SC1569  
2SC4544  
2SA1788  
2SA1306  
2SA1186A

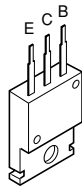

③ 2SC752GTM  
2SC2482  
2SC2655  
2SC4721P

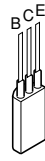

④ 2SC752  
2SA562TM  
2SA1015  
2SC1815  
2SC2878  
2SC1740S  
2SC2120  
2SA9335

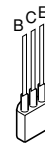

⑤ 2SA1788

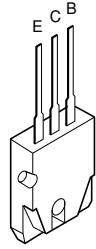

⑥ RN2203  
RN2201  
RN2004  
RN1203  
RN1204  
RN2204  
RN1205  
RN1202  
RN1201

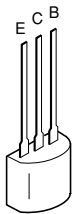

⑦ 2SD1554  
2SD2253  
2SD1556  
2SC5143  
2SD2553

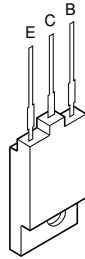

⑧ ON4409

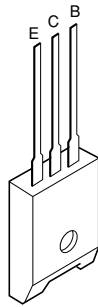

**THIS PAGE IS  
INTENTIONALLY LEFT  
BLANK.**



# CIRCUIT BLOCK DIAGRAM

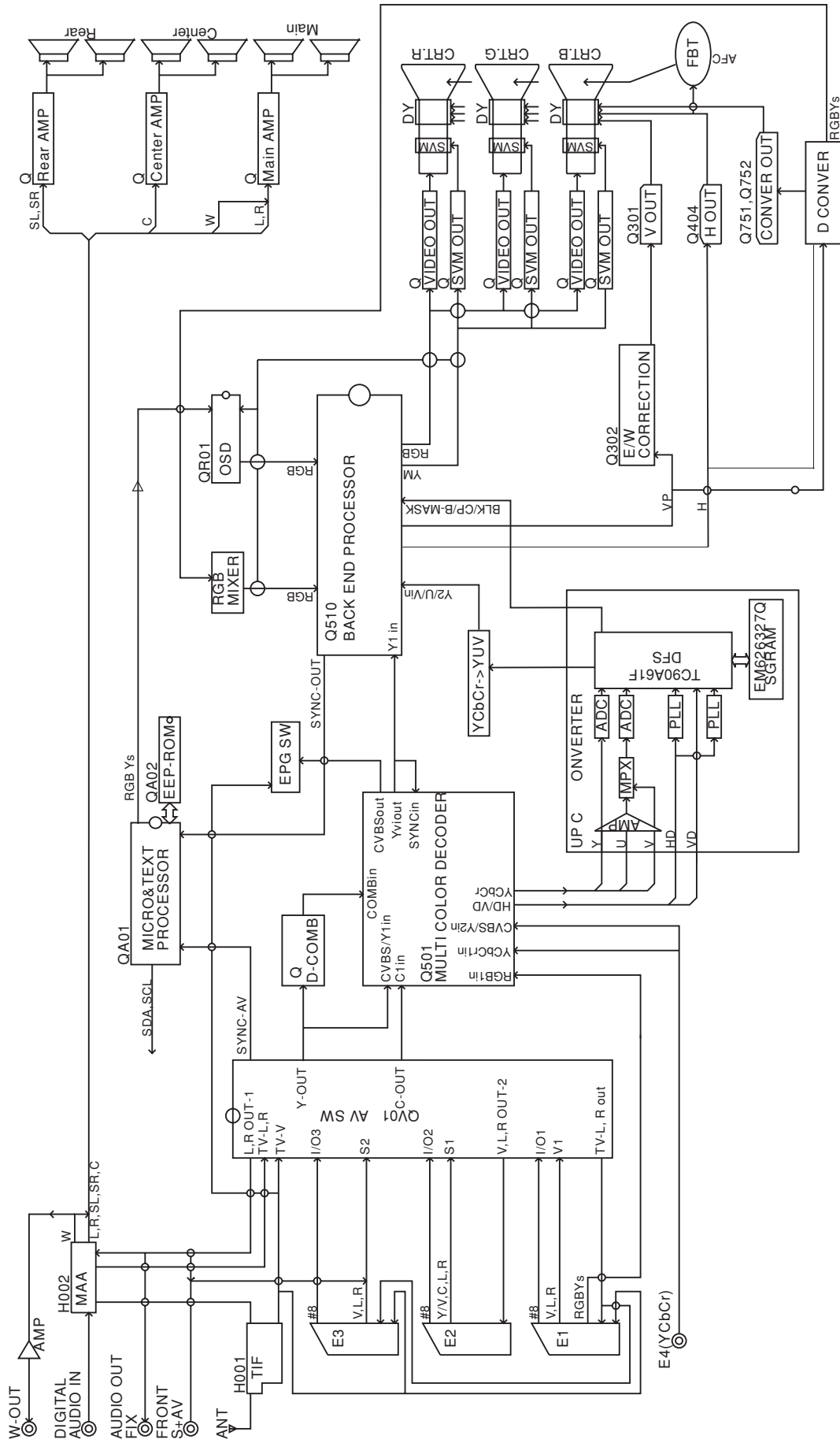

2001 Euro PJTV CIRCUIT BLOCK DIAGRAM



### SPECIFICATIONS

Rated voltage		AC 220 V – 240 V, 50/60 Hz				
Dimensions (Width × Height × Depth)		958 mm × 1163 mm × 442 mm				
Mass		49.5 kg				
Screen size		Type 43				
Television system (Aerial input)	Channel coverage	<b>System</b>	<b>Channel</b>	<b>VHF</b>	<b>UHF</b>	<b>CATV</b>
	Special RF signal	<b>Colour system</b>	<b>Sound system</b>			
		PAL B/G	CCIR	2 – 12	21 – 69	X ~ Z+2, S1 ~ S41
		PAL I	UK	—	21 – 69	—
		SECAM L	CCIR	*	21 – 69	* VHF : B-C ; 1-6, B-Q, 71-86
		SECAM D/K	OIRT	1 – 12	21 – 69	X1 ~ X19
		4.43NTSC	5.5/6.0/6.5 MHz			
		PAL 60Hz	5.5/6.0/6.5 MHz			
Colour system		PAL/SECAM/4.43NTSC/3.58NTSC				
Sound output		14 W + 14 W				
Accessories		<ul style="list-style-type: none"> <li>• Remote control unit           × 1</li> <li>• Battery (R03, AAA)           × 2</li> </ul>				

\* Please refer to owner's manual in detail.

**TOSHIBA CORPORATION**  
1-1, SHIBAURA 1-CHOME, MINATO-KU, TOKYO 105-8001, JAPAN